



### BEST QUALITY MADE IN GERMANY

Our high-quality, robust transport and storage containers are developed and manufactured exclusively in Germany. Our wide range of products is manufactured on computer-controlled machines in our modern plants in Amerang and Hohenpeißenberg, where innovations are promptly put into practice. This way we ensure best quality, economical production and flexibility.

We use only new material of 1A quality for the production of our containers. As no recycled materials are used in the production, we can guarantee a constantly very high product-quality to our customers.

We use different materials for different requirements and applications with regard to e.g. temperature stability, weight-bearing capacity, impact resistance, suitability for cleaning plants etc. Naturally, the transport containers produced by AUER Packaging are optimized for automatic handling.



### TOP QUALITY AT A REASONABLE PRICE – DIRECTLY FROM THE MANUFACTURER!

Transport containers manufactured by AUER Packaging are adapted exactly to the needs of modern transport. National and international standards for modern logistics were taken into consideration in the development stage. The dimensions offered are compatible with customary pallet sizes. Our containers are extremely robust – and at the same time surprisingly light! With thought-out detailed solutions and functional accessories they fulfil the varied demands of a vast number of industries.

You buy AUER transport containers directly from the manufacturer and therefore at extremely good prices – without any additional surcharges! Individual requests such as printing or special models can be coordinated and realised directly.



### QUICK SERVICE



At the annual liquidity rating of the rating agency Hoppenstedt, Auer Packaging was assessed with the top mark of 1.0 as „Top Business Partner“ for the year of 2012 - an decoration which is only given to 4.4 % of 4.2 m. tested companies.

We execute all orders quickly and reliably – our order-placing processes are incomparably short! Serving all our customers directly, without any sales representatives, we are able to offer quicker and more efficient services – and naturally also top prices.

We are happy to advise you on the telephone regarding your transport requirements and offer you solutions – including custom-made products, if required. All products can also be supplied in very small quantities up from 1 item at the per-carton prices.



The per-pallet price is only applicable for complete pallets. Custom-made products and imprints on request.  
The prices quoted are net prices effective ex works exclusive of transport costs and VAT.

# TABLE OF CONTENTS

FIND OUR PRODUCTS HERE

## EURO CONTAINERS



## TRANSPORT TROLLEYS



## RACK- AND FLOW MATERIAL BOXES



## SPECIAL INSERTS



## FOLDABLE BOXES



## REUSABLE CONTAINERS



## SMALL LOAD CONTAINERS / KLT



## BIG BOXES



## COLLAPSIBLE BIG BOXES



## BAG IN BOX SYSTEM / IBC



## PLASTIC PALLETS



## MEAT INDUSTRY

HYGIENIC PALLETS, MEAT CRATE



## ESD-PRODUCTS



## PAILS



## RAINWATER SOAKAWAY RIGOLETTO



## BOTTLE CRATE



## SPECIAL COLOURS



## LABEL HOLDER / SELF-ADHESIVE BAGS / IMPRINTINGS





REEF  
... das Paket für den Profi.

REEF  
... das Paket für den Profi.

REEF  
... das Paket für den Profi.

**REEF POWER-BOX**  
... das Paket für den Profi.

REEF  
... das Paket für den Profi.



# EURO CONTAINERS SOLID

## COMPACT STORAGE FOR YOUR INDIVIDUAL REQUIREMENTS

The practical Euro containers manufactured by AUER Packaging are ideal for use wherever hygienic stackable plastic containers play an important role in transport and storage.

- not sensitive to acid or alkaline solutions
- available in all popular sizes
- cold- and heat-resistant
- optimal handling due to ergonomic handles
- also suitable for conveyor systems



**SPECIAL COLOURS**  
Available in all RAL-colours for an additional surcharge (P. 100)

Order now & save money!  
e.g.:  
Euro containers solid  
60 x 40 x 22 cm  
EG 64/22  
Price/Unit on pallet

Our best price  
from €

**6,90**



### PLACE-ON LID WITHOUT HINGES

Dimensions L x W (cm)	Article No.	Colour	Units per carton	Price/Unit in carton	Units per pallet	Price/Unit on pallet
40 x 30	DE 43	silver grey	100	3,20 €	800	2,67 €
60 x 40	DE 64	silver grey	45	3,95 €	600	3,29 €
80 x 60	DE 86	silver grey	20	12,77 €	300	10,64 €

### LABEL HOLDER TO PUT ON THE BOX

Article No.	Colour	Model	Units per carton	Price/Unit in carton
ET	silver grey	stainless steel clip for attaching documents	100	0,90 €

### EURO CONTAINERS SOLID

Dimensions L x W x H (cm)	Article No.	Colour	Units per carton	Price/Unit in carton	Units per pallet	Price/Unit on pallet
40 x 30 x 12	EG 43/12 HG	silver grey	30	4,24 €	190	3,53 €
40 x 30 x 17	EG 43/17	silver grey	24	4,94 €	130	4,12 €
40 x 30 x 22	EG 43/22	silver grey	18	5,69 €	100	4,74 €
40 x 30 x 27	EG 43/27	silver grey	12	6,22 €	80	5,18 €
40 x 30 x 32	EG 43/32	silver grey	6	6,98 €	70	5,82 €
60 x 40 x 7,5	EG 64/75 HG	silver grey	21	6,05 €	140	5,04 €
60 x 40 x 12	EG 64/12	silver grey	15	6,80 €	75	5,67 €
60 x 40 x 17	EG 64/17	silver grey	9	7,44 €	60	6,20 €
60 x 40 x 22	EG 64/22	silver grey	9	8,28 €	45	6,90 €
60 x 40 x 27	EG 64/27	silver grey	9	8,88 €	40	7,40 €
60 x 40 x 32	EG 64/32	silver grey	6	9,54 €	45	7,95 €
60 x 40 x 42	EG 64/42	silver grey	3	11,89 €	30	9,91 €
80 x 60 x 12	EG 86/12 HG	silver grey	4	16,85 €	34	14,04 €
80 x 60 x 22	EG 86/22	silver grey	2	21,54 €	20	17,95 €
80 x 60 x 32	EG 86/32	silver grey	1	25,74 €	12	21,45 €
80 x 60 x 42	EG 86/42	silver grey	1	29,64 €	10	24,70 €

Secure logistics and storage containers from the AUER Packaging range. Dimensions of all containers correspond with Euro pallets.

- Also stackable with lid.
- Lid with two hinges, fastened by two clasps.



**AVAILABLE UP FROM 1 PIECE!**  
No minimum purchase order. Excl. VAT; The per-pallet price is only applicable for complete pallets.

Order now & save money!  
e.g.:  
Euro containers solid  
60 x 40 x 23,5 cm  
ED 64/22  
Price/Unit on pallet

Our best price  
from €  
**11,50**

### EURO CONTAINERS INCL. HINGED LID + 2 CLASPS

Dimensions L x W x H (cm)	Article No.	Colour	Units per carton	Price/Unit in carton	Units per pallet	Price/Unit on pallet
40 x 30 x 13,5	ED 43/12 HG	silver grey	24	9,17 €	160	7,64 €
40 x 30 x 18,5	ED 43/17	silver grey	18	9,84 €	120	8,20 €
40 x 30 x 23,5	ED 43/22	silver grey	12	10,44 €	90	8,70 €
40 x 30 x 28,5	ED 43/27	silver grey	12	11,18 €	70	9,32 €
40 x 30 x 33,5	ED 43/32	silver grey	6	12,00 €	60	10,00 €
60 x 40 x 9	ED 64/75 HG	silver grey	21	11,66 €	130	9,72 €
60 x 40 x 13,5	ED 64/12	silver grey	12	12,32 €	75	10,27 €
60 x 40 x 18,5	ED 64/17	silver grey	9	12,96 €	60	10,80 €
60 x 40 x 23,5	ED 64/22	silver grey	6	13,80 €	45	11,50 €
60 x 40 x 28,5	ED 64/27	silver grey	6	14,27 €	35	11,89 €
60 x 40 x 33,5	ED 64/32	silver grey	3	14,64 €	30	12,20 €
60 x 40 x 43,5	ED 64/42	silver grey	3	17,17 €	25	14,31 €
80 x 60 x 14	ED 86/12 HG	silver grey	4	34,85 €	34	29,04 €
80 x 60 x 24	ED 86/22	silver grey	2	39,54 €	18	32,95 €
80 x 60 x 34	ED 86/32	silver grey	1	43,74 €	12	36,45 €
80 x 60 x 44	ED 86/42	silver grey	1	47,64 €	10	39,70 €

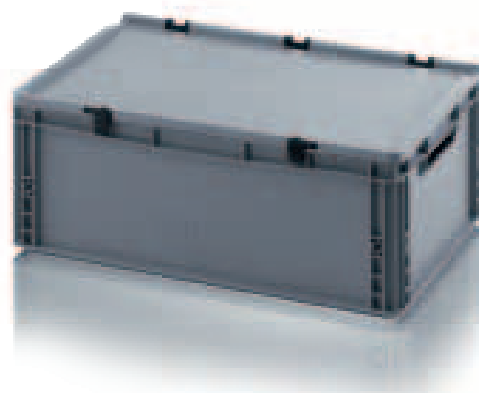

The latticed euro containers by AUER Packaging have effective ventilation slots – a great advantage for transporting and storing foodstuffs.

Additionally, liquids can drain from the container easily, and dampness will not accumulate. When stacked, it can be determined quickly whether the container is full or empty.

Suitable for direct food contact and easy to clean.



### SPECIAL COLOURS

Available in all RAL-colours for an additional surcharge (P.100)



Order now & save money!

e.g.:

60 x 40 x 22

EO 64/22

Price/Unit on pallet

Our best price  
from €

**6,90**

### EURO CONTAINERS PERFORATED BASIC DIMENSIONS 60 X 40 CM

Dimensions L x W x H (cm)	Article No.	Colour	Units per carton	Price/Unit in carton	Units per pallet	Price/Unit on pallet
60 x 40 x 7,5	EO 64/75	silver grey	21	6,05 €	140	5,04 €
60 x 40 x 12	EO 64/12	silver grey	15	6,80 €	75	5,67 €
60 x 40 x 15	EO 64/15	silver grey	9	7,44 €	60	6,20 €
60 x 40 x 17	EO 64/17	silver grey	9	7,44 €	60	6,20 €
60 x 40 x 22	EO 64/22	silver grey	9	8,28 €	45	6,90 €
60 x 40 x 27	EO 64/27	silver grey	9	8,88 €	40	7,40 €
60 x 40 x 32	EO 64/32	silver grey	9	9,54 €	45	7,95 €
60 x 40 x 42	EO 64/42	silver grey	3	11,89 €	25	9,91 €

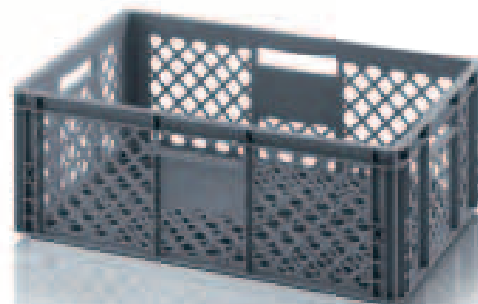



## SAFELY COVERED

To cover your goods on the pallet in a safe and protective way.

- Three banding grooves
- Two lengthwise bars prevent stapled pallets from slipping



Order now & save money!  
e.g.  
cover for pallets  
122 x 102 x 4  
A 1210

Our best price  
from €

**32,50**

### COVER FOR PALLETS

Dimensions L x W x H (cm)	Article No.	Colour	Price for single unit	Units per storing position	Price/Unit per storing position
122 x 82 x 4	A 1208	black	37,44 €	50	31,20 €
122 x 102 x 4	A 1210	black	39,00 €	50	32,50 €

# EURO CONTAINERS

## WITH CLOSING SYSTEM

Safely prepare, transport and store with lockable euro containers from AUER Packaging: two simultaneously locking, high-quality locks protect your goods from unauthorized access!

All plastic boxes fit the dimensional standards for euro pallets.

- Also stackable with lid
- Hinged lid
- With two simultaneously locking padlocks



Order now & save money!  
e.g.  
Euro containers with closing system  
60 x 40 x 23,5 cm  
ED 64/22 HG 2S  
Price/Unit on pallet

Our best price  
from €

**42,50**

**SPECIAL COLOURS**  
Available in all RAL-colours for  
an additional surcharge (P. 100)



### EURO CONTAINERS WITH CLOSING SYSTEM

Dimensions L x W x H (cm)	Article No.	Colour	Units per carton	Price/Unit in carton	Units per pallet	Price/Unit on pallet
40 x 30 x 13,5	ED 43/12 HG 2S	silver grey	24	46,37 €	160	38,64 €
40 x 30 x 18,5	ED 43/17 HG 2S	silver grey	18	47,04 €	120	39,20 €
40 x 30 x 23,5	ED 43/22 HG 2S	silver grey	12	47,64 €	90	39,70 €
40 x 30 x 28,5	ED 43/27 HG 2S	silver grey	12	48,38 €	70	40,32 €
40 x 30 x 33,5	ED 43/32 HG 2S	silver grey	6	49,20 €	60	41,00 €
60 x 40 x 13,5	ED 64/12 HG 2S	silver grey	12	49,52 €	75	41,27 €
60 x 40 x 18,5	ED 64/17 HG 2S	silver grey	9	50,16 €	60	41,80 €
60 x 40 x 23,5	ED 64/22 HG 2S	silver grey	6	51,00 €	45	42,50 €
60 x 40 x 28,5	ED 64/27 HG 2S	silver grey	6	51,47 €	35	42,89 €
60 x 40 x 33,5	ED 64/32 HG 2S	silver grey	3	51,84 €	30	43,20 €
60 x 40 x 43,5	ED 64/42 HG 2S	silver grey	3	54,37 €	25	45,31 €
80 x 60 x 14	ED 86/12 HG 2S	silver grey	4	72,05 €	34	60,04 €
80 x 60 x 24	ED 86/22 HG 2S	silver grey	2	76,74 €	18	63,95 €
80 x 60 x 34	ED 86/32 HG 2S	silver grey	1	80,94 €	12	67,45 €
80 x 60 x 44	ED 86/42 HG 2S	silver grey	1	84,84 €	10	70,70 €
	2S	Sealing system set (two pieces) including assembly material for self assembly				30,00 €

## 1 HANDLE ON THE LENGTH SIDE

The AUER Euro container with the handle on the length side becomes a practical and sturdy bag to carry

- Also stackable with lid
- Lid with 2 hinges and 2 lock handles
- 1 handle on the length side



Order now & save money!  
e.g.  
solid Euro containers  
60 x 40 x 23,5 cm  
ED 64/22 HG 1G  
Price/Unit on pallet

Our best price from €

**21,<sup>50</sup>**

### EURO CONTAINER INCL. HINGE LID + 2 CLOSURES + 1 HANDLES ON THE LENGTH SIDE

Dimensions L x W x H (cm)	Article No.	Colour	Units per carton	Price/Unit in carton	Units per pallet	Price/Unit on pallet
40 x 30 x 13,5	ED 43/12 HG 1G	silver grey	24	21,17 €	160	17,64 €
40 x 30 x 18,5	ED 43/17 HG 1G	silver grey	18	21,84 €	120	18,20 €
40 x 30 x 23,5	ED 43/22 HG 1G	silver grey	12	22,44 €	90	18,70 €
40 x 30 x 28,5	ED 43/27 HG 1G	silver grey	12	23,18 €	70	19,32 €
40 x 30 x 33,5	ED 43/32 HG 1G	silver grey	6	24,00 €	60	20,00 €
60 x 40 x 9	ED 64/75 HG 1G	silver grey	21	23,66 €	130	19,72 €
60 x 40 x 13,5	ED 64/12 HG 1G	silver grey	12	24,32 €	75	20,27 €
60 x 40 x 18,5	ED 64/17 HG 1G	silver grey	9	24,96 €	60	20,80 €
60 x 40 x 23,5	ED 64/22 HG 1G	silver grey	6	25,80 €	45	21,50 €
60 x 40 x 28,5	ED 64/27 HG 1G	silver grey	6	26,27 €	35	21,89 €
60 x 40 x 33,5	ED 64/32 HG 1G	silver grey	3	26,64 €	30	22,20 €
60 x 40 x 43,5	ED 64/42 HG 1G	silver grey	3	29,17 €	25	24,31 €
80 x 60 x 14	ED 86/12 HG 1G	silver grey	4	46,85 €	34	39,04 €
80 x 60 x 24	ED 86/22 HG 1G	silver grey	2	51,54 €	18	42,95 €
80 x 60 x 34	ED 86/32 HG 1G	silver grey	1	55,74 €	12	46,45 €
80 x 60 x 44	ED 86/42 HG 1G	silver grey	1	59,64 €	10	49,70 €



Also in ESD-Version available.

**SPECIAL COLOURS**  
Available in all RAL-colours for an additional surcharge (P. 100)



# EURO CONTAINER CASE

## 2 HANDLES ON THE SHORT SIDE

In contrast to conventional Euro containers the handles are always closed. So the products are perfectly protected on all sides, falling out of small parts is excluded.

- Also stackable with lid
- Lid with 2 hinges and 2 lock handles
- 2 handles on the short side

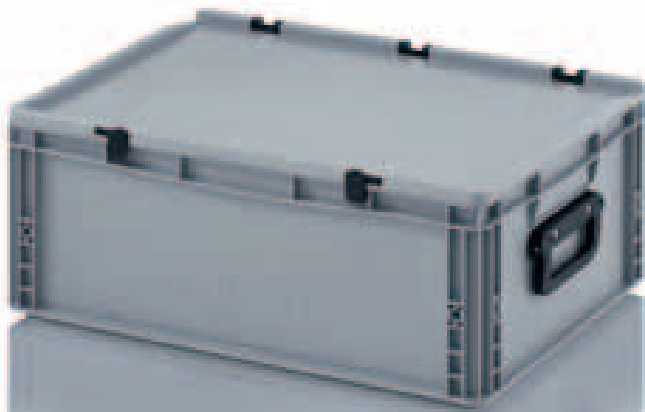

Order now & save money!  
e.g.  
solid Euro containers  
60 x 40 x 23,5 cm  
ED 64/22 HG 2G  
Price/Unit on pallet

Our best price from €

**31,<sup>50</sup>**

### EURO CONTAINER INCL. HINGE LID + 2 CLOSURES + 2 HANDLES ON THE SHORT SIDE

Dimensions L x W x H (cm)	Article No.	Colour	Units per carton	Price/Unit in carton	Units per pallet	Price/Unit on pallet
40 x 30 x 13,5	ED 43/12 HG 2G	silver grey	24	33,17 €	160	27,64 €
40 x 30 x 18,5	ED 43/17 HG 2G	silver grey	18	33,84 €	120	28,20 €
40 x 30 x 23,5	ED 43/22 HG 2G	silver grey	12	34,44 €	90	28,70 €
40 x 30 x 28,5	ED 43/27 HG 2G	silver grey	12	35,18 €	70	29,32 €
40 x 30 x 33,5	ED 43/32 HG 2G	silver grey	6	36,00 €	60	30,00 €
60 x 40 x 9	ED 64/75 HG 2G	silver grey	21	35,66 €	130	29,72 €
60 x 40 x 13,5	ED 64/12 HG 2G	silver grey	12	36,32 €	75	30,27 €
60 x 40 x 18,5	ED 64/17 HG 2G	silver grey	9	36,96 €	60	30,80 €
60 x 40 x 23,5	ED 64/22 HG 2G	silver grey	6	37,80 €	45	31,50 €
60 x 40 x 28,5	ED 64/27 HG 2G	silver grey	6	38,27 €	35	31,89 €
60 x 40 x 33,5	ED 64/32 HG 2G	silver grey	3	38,64 €	30	32,20 €
60 x 40 x 43,5	ED 64/42 HG 2G	silver grey	3	41,17 €	25	34,31 €
80 x 60 x 14	ED 86/12 HG 2G	silver grey	4	58,85 €	34	49,04 €
80 x 60 x 24	ED 86/22 HG 2G	silver grey	2	63,54 €	18	52,95 €
80 x 60 x 34	ED 86/32 HG 2G	silver grey	1	67,74 €	12	56,45 €
80 x 60 x 44	ED 86/42 HG 2G	silver grey	1	71,64 €	10	59,70 €





# TRANSPORT TROLLEYS

## BE STABLE AND MOBILE

With this trolley you can easily move your eurocontainers from A to B. The size of the trolleys is attuned for a basic measurement of 60 cm x 40 but can also be used for 2 containers with the dimensions of 40 cm x 30 cm.

- Highly robust, loading capacity 250 kg
- High quality, smooth running wheels
- Available with rubber or polyamide wheels

- Our polyamide version is also available with stainless steel blocks
- Trolleys are available with 4 steering wheels or with 2 fixed and 2 steering wheels
- Optionally with parking brakes or thread guards

Also order:  
Transport trolleys  
Very robust,  
load-bearing capacity 250 kg  
RO 64 R GU  
Price/Unit on pallet

Our best price  
from €  
**22,95**



### TRANSPORT TROLLEYS WITH RUBBER WHEELS

Dimensions L x W (cm)	Article No.	Model	Colour	Units/carton	Price/Unit in carton	Units/pallet	Price/Unit on pallet
62 x 42	RO 64 R GU	4 steering castors	red	7	27,54 €	80	22,95 €
62 x 42	RO 64 B GU	4 steering castors	blue	7	27,54 €	80	22,95 €
62 x 42	RO 64 R GU FE	2 steering castors, 2 steering castors with wheel stop	red	7	31,50 €	80	26,25 €
62 x 42	RO 64 B GU FE	2 steering castors, 2 steering castors with wheel stop	blue	7	31,50 €	80	26,25 €
62 x 42	RO 64 R GU FA	4 steering castors with threadguard	red	7	29,17 €	80	24,31 €
62 x 42	RO 64 B GU FA	4 steering castors with threadguard	blue	7	29,17 €	80	24,31 €
62 x 42	RO 64 R GU BO	2 steering castors, 2 fixed castors	red	7	27,80 €	80	23,17 €
62 x 42	RO 64 B GU BO	2 steering castors, 2 fixed castors	blue	7	27,80 €	80	23,17 €

### TRANSPORT TROLLEYS WITH WHEELS OF POLYAMIDE

Dimensions L x W (cm)	Article No.	Model	Colour	Units per carton	Price/Unit in carton	Units per pallet	Price/Unit on pallet
62 x 42	RO 64 R PAX	4 stainless steel steering castors	red	7	47,94 €	80	39,95 €
62 x 42	RO 64 B PAX	4 stainless steel steering castors	blue	7	47,94 €	80	39,95 €
62 x 42	RO 64 R PA	4 steering castors	red	7	27,25 €	80	22,71 €
62 x 42	RO 64 B PA	4 steering castors	blue	7	27,25 €	80	22,71 €
62 x 42	RO 64 R PA BO	2 steering castors, 2 fixed castors	red	7	26,82 €	80	22,35 €
62 x 42	RO 64 B PA BO	2 steering castors, 2 fixed castors	blue	7	26,82 €	80	22,35 €
62 x 42	RO 64 R PAX BO	2 stainless steel steering castors, 2 stainless steel fixed castors	red	7	43,43 €	80	36,19 €
62 x 42	RO 64 B PAX BO	2 stainless steel steering castors, 2 stainless steel fixed castors	blue	7	43,43 €	80	36,19 €

For bigger quantities our transport trolleys 80 x 60 can either be used for several small containers or for our 80 x 60 boxes! The recess on top of each trolley enables you to stack them easy and space saving.

- Highly robust
- Loading capacity 250 kg
- High quality, smooth running wheels
- Available with rubber or polyamide wheels
- Our polyamide version is also available with stainless steel blocks
- Trolleys are available with 4 steering wheels or with 2 fixed and 2 steering wheels
- Optionally with parking brakes or thread guards

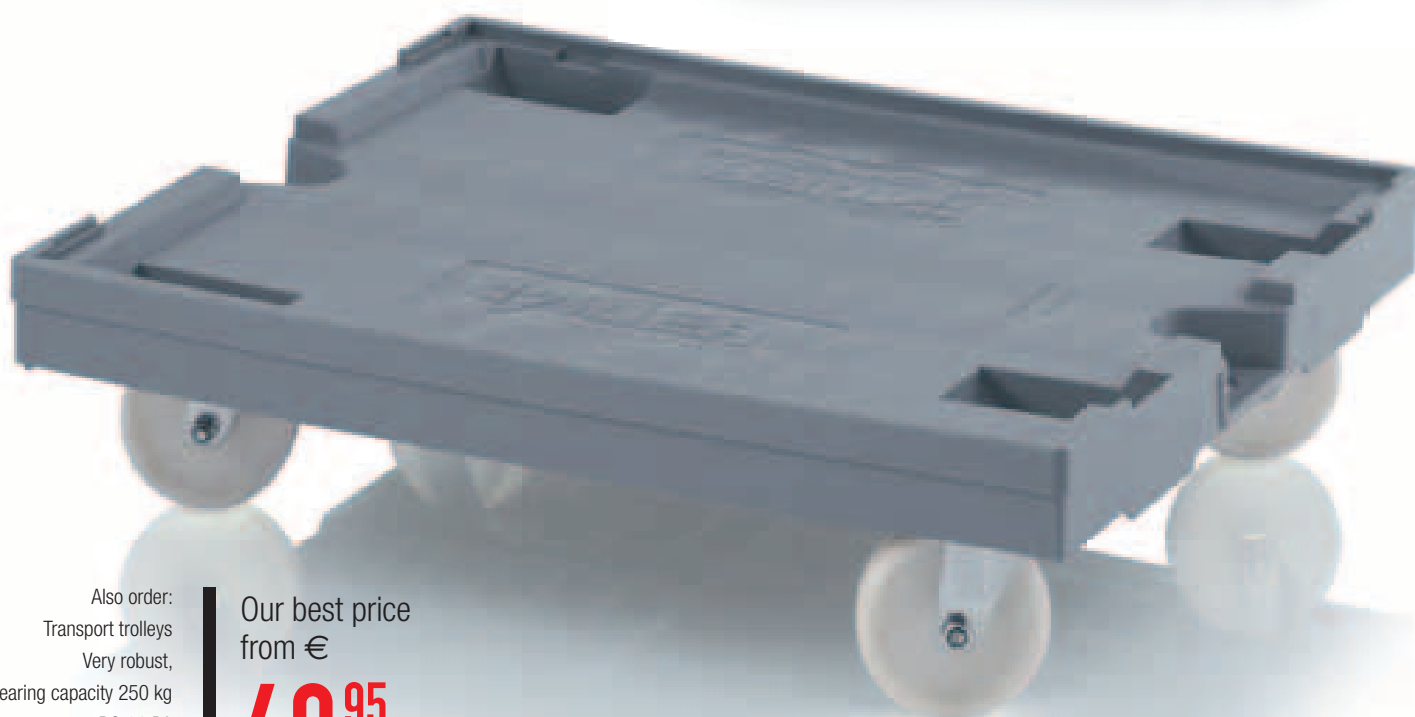

Also order:  
Transport trolleys  
Very robust,  
load-bearing capacity 250 kg  
RO 86 PA  
Price/Unit on pallet

Our best price  
from €

**49,<sup>95</sup>**

### TRANSPORT TROLLEYS 82 X 62 CM WITH RUBBER WHEELS

Dimensions L x W (cm)	Article No.	Model	Colour	Units per carton	Price/Unit in carton	Units per pallet	Price/Unit on pallet
82 x 62	RO 86 GU	4 steering castors	silver grey	3	63,16 €	32	52,63 €
82 x 62	RO 86 GU BO	2 steering castors, 2 fixed castors	silver grey	3	62,68 €	32	52,23 €
82 x 62	RO 86 GU FE	2 steering castors, 2 steering castors with wheel stop	silver grey	3	67,09 €	32	55,91 €
82 x 62	RO 86 GU BO FA	2 steering castors with threadguard, 2 fixed castors with threadguard	silver grey	3	65,56 €	32	54,63 €
82 x 62	RO 86 GU FA	4 steering castors with threadguard	silver grey	3	66,04 €	32	55,03 €

### TRANSPORT TROLLEYS 82 X 62 CM WITH WHEELS OF POLYAMIDE

Dimensions L x W (cm)	Article No.	Model	Colour	Units per carton	Price/Unit in carton	Units per pallet	Price/Unit on pallet
82 x 62	RO 86 PA	4 steering castors	silver grey	3	59,94 €	32	49,95 €
82 x 62	RO 86 PA BO	2 steering castors, 2 fixed castors	silver grey	3	58,96 €	32	49,13 €
82 x 62	RO 86 PA FE	2 steering castors, 2 steering castors with wheel stop	silver grey	3	63,54 €	32	52,95 €
82 x 62	RO 86 PA BO FA	2 steering castors with threadguard, 2 fixed castors with threadguard	silver grey	3	62,32 €	32	51,93 €
82 x 62	RO 86 PA FA	4 steering castors with threadguard	silver grey	3	62,87 €	32	52,39 €







Rack- and  
flow material  
boxes

# EURO STORAGE CONTAINERS WITH OPEN FRONTS

## READY-TO-HAND SYSTEM

For an easy and quick grab at screws, tools, textiles or other small things: Robust plastic open-front containers for easy filling and

emptying even when stacked. All models with different open fronts available. Also on the length side possible.



**SPECIAL COLOURS**  
Available in all RAL-colours for an additional surcharge (P. 100)



Order now & save money!  
e.g.

Euro open-front Storage  
Container

60 x 40 x 42  
SLK 64/42

Price/Unit on pallet

Our best price  
from €

**10,<sup>86</sup>**

### EURO OPEN-FRONT CONTAINERS

Dimensions L x W x H (cm)	Article No.	Opening (cm)	Units per carton	Price/Unit carton	Units per pallet	Price/Unit Palette
40 x 30 x 22	SLK 43/22	20 x 12	18	7,07 €	100	5,89 €
40 x 30 x 27	SLK 43/27	20 x 17	12	7,60 €	80	6,33 €
40 x 30 x 32	SLK 43/32	20 x 22	6	8,36 €	70	6,97 €
60 x 40 x 22	SLK 64/22	31 x 13	9	9,66 €	45	8,05 €
60 x 40 x 27	SLK 64/27	31 x 18	9	9,96 €	40	8,30 €
60 x 40 x 32	SLK 64/32	31 x 22	9	11,88 €	45	9,90 €
60 x 40 x 42	SLK 64/42	31 x 22	3	13,03 €	30	10,86 €
80 x 60 x 32	SLK 86/32	49 x 21	1	26,74 €	12	22,45 €
80 x 60 x 42	SLK 86/42	49 x 31	1	30,64 €	10	25,70 €

All models with different open fronts available. (Also on the length side possible)



## WITHIN EASY REACH

Can easily be integrated into all rack systems. The versatile and compatible dimensions enable use in any combination.



Rack- and flow material boxes



**AVAILABLE UP FROM 1 PIECE!**  
No minimum purchase order. Excl. VAT; The per-pallet price is only applicable for complete pallets.

Order now & save money!  
e.g.  
Open-front Containers  
16 x 10 x 7,5 cm  
SLK 2 r  
Price/Unit on pallet

Our best price  
from €

**0,50**

**SPECIAL COLOURS**  
Available in all RAL-colours for an additional surcharge (P.100)



### STORAGE BOXES WITH OPEN FRONT

Dimensions L x W x H (cm)	Article No.	Colour	Units per carton	Price/Unit carton	Units per pallet	Price/Unit Palette
16 x 10 x 7,5	SLK 2 b	blue	360	0,60 €	1200	0,50 €
16 x 10 x 7,5	SLK 2 r	red	360	0,60 €	1200	0,50 €
21,5 x 10 x 7,5	SLK 2L b	blue	324	0,73 €	900	0,61 €
21,5 x 10 x 7,5	SLK 2L r	red	324	0,73 €	900	0,61 €
23 x 15 x 12,5	SLK 3 b	blue	120	1,42 €	416	1,18 €
23 x 15 x 12,5	SLK 3 r	red	120	1,42 €	416	1,18 €
31,5 x 15 x 12,5	SLK 3L b	blue	70	2,29 €	252	1,91 €
31,5 x 15 x 12,5	SLK 3L r	red	70	2,29 €	252	1,91 €
35 x 21 x 15	SLK 4 b	blue	48	3,54 €	180	2,95 €
35 x 21 x 15	SLK 4 r	red	48	3,54 €	180	2,95 €
50 x 31,5 x 20	SLK 5 b	blue	12	5,94 €	72	4,95 €
50 x 31,5 x 20	SLK 5 r	red	12	5,94 €	72	4,95 €

# RACK- AND FLOW MATERIAL BOXES

## IDEAL FOR SHELVES

A perfect solution to order your warehouse:  
The storage boxes (approximately available in autumn 2012) were especially attuned for the AUER-shelve system, which is also in planning. The big labels (1 pcs per box already included) ensure perfect order.

- Make your work-flow easier
- Very stable design
- huge storing space
- stackable



### SHELVE CONTAINERS

Dimensions L x W x H (cm)	Article No.	Colour
30 x 11,7 x 9	RK 3109	blue
30 x 15,6 x 9	RK 31509	blue
30 x 23,4 x 9	RK 3209	blue
30 x 23,4 x 14	RK 3214	blue
40 x 11,7 x 9	RK 4109	blue
40 x 15,6 x 9	RK 41509	blue
40 x 23,4 x 9	RK 4209	blue
40 x 23,4 x 14	RK 4214	blue
50 x 11,7 x 9	RK 5109	blue
50 x 15,6 x 9	RK 51509	blue
50 x 23,4 x 9	RK 5209	blue
50 x 23,4 x 14	RK 5214	blue
60 x 11,7 x 9	RK 6109	blue
60 x 15,6 x 9	RK 61509	blue
60 x 23,4 x 9	RK 6209	blue
60 x 23,4 x 14	RK 6214	blue

### ACCESSORIES FOR SHELVES CONTAINERS

Article No.	suitable for
<b>TRANSVERSE DIVIDER</b>	
QT 109	RK 3109, RK 4109, RK 5109, RK 6109
QT 1509	RK 31509, RK 41509, RK 51509, RK 61509
QT 209	RK 3209, RK 4209, RK 5209, RK 6209
QT 214	RK 3214, RK 4214, RK 5214, RK 6214
<b>LONGITUDINAL DIVIDER</b>	
LT 309	RK 3109, RK 31509, RK 3209
LT 314	RK 3214
LT 409	RK 4109, RK 41509, RK 4209
LT 414	RK 4214
LT 509	RK 5109, RK 41509, RK 5209
LT 514	RK 5214
LT 609	RK 6109, RK 61509, RK 6209
LT 614	RK 6214
<b>SAFETY HANDLE</b>	
SB 117	RK 3109, RK 4109, RK 5109, RK 6109
SB 156	RK 31509, RK 41509, RK 51509, RK 61509
SB 234	RK 3214, RK 4214, RK 5214, RK 6214

Article No.	suitable for
<b>DUST LID</b>	
SD 3117	300 x 117 cm
SD 3156	300 x 156 cm
SD 3234	300 x 234 cm
SD 4117	400 x 117 cm
SD 4156	400 x 156 cm
SD 4234	400 x 234 cm
SD 5117	500 x 117 cm
SD 5156	500 x 156 cm
SD 5234	500 x 234 cm
SD 6117	600 x 117 cm
SD 6156	600 x 156 cm
SD 6234	600 x 234 cm
<b>PERFORATED LABELS</b>	
PE 117	RK 3109, RK 4109, RK 5109, RK 6109
PE 156	RK 31509, RK 41509, RK 51509, RK 61509
PE 234	RK 3209, RK 4214, RK 4209, RK 4214, RK 5209, RK 5214, RK 6209, RK 6214

With this system you will always have a clear view of everything: the transparent tipping boxes (approximately available in autumn 2012) make it easy to see what's inside. To fill or empty the boxes, they just have to be tilted forward but they will still remain safe in their fixing module. With just one hand movement more you can also take the containers out of the fixing module - so you can be completely flexible.

- made of transparent, scratch-proof plastics
- individual stackable or usable in wall mounting system
- labels are included in scope of delivery

Rack- and flow material boxes



### TIPPING BOX SETS

Dimensions L x W x H (cm)	Article No.	Colour	Model
60 x 7,7 x 6,2	KKS 9 b	sky blue	1 x KM 9 b, 9 x EBKK 9
60 x 11,3 x 9,1	KKS 6 b	sky blue	1 x KM 6 b, 6 x EBKK 6
60 x 16,4 x 13,3	KKS 5 b	sky blue	1 x KM 5 b, 5 x EBKK 5
60 x 20,7 x 16,8	KKS 4 b	sky blue	1 x KM 4 b, 4 x EBKK 4
60 x 24,0 x 19,7	KKS 3 b	sky blue	1 x KM 3 b, 3 x EBKK 3
60 x 35,3 x 29,9	KKS 2 b	sky blue	1 x KM 2 b, 2 x EBKK 2
60 x 7,7 x 6,2	KKS 9 g	silver grey	1 x KM 9 g, 9 x EBKK 9
60 x 11,3 x 9,1	KKS 6 g	silver grey	1 x KM 6 g, 6 x EBKK 6
60 x 16,4 x 13,3	KKS 5 g	silver grey	1 x KM 5 g, 5 x EBKK 5
60 x 20,7 x 16,8	KKS 4 g	silver grey	1 x KM 4 g, 4 x EBKK 4
60 x 24 x 19,7	KKS 3 g	silver grey	1 x KM 3 g, 3 x EBKK 3
60 x 35,3 x 29,9	KKS 2 g	silver grey	1 x KM 2 g, 2 x EBKK 2

### SINGLE CONTAINERS FOR TIPPING BOX MODULES

Dimensions L x W x H (cm)	Article No.	Colour
6 x 6,6 x 5,6	EBKK 9	transparent
9,3 x 10 x 8,4	EBKK 6	transparent
11,3 x 15,2 x 12,9	EBKK 5	transparent
14,2 x 19 x 16,5	EBKK 4	transparent
19,2 x 22 x 19	EBKK 3	transparent
28,8 x 33,8 x 28,5	EBKK 2	transparent

### PERFORATED LABELS

Article No.	suitable for	Article No.	suitable for
PE 9	EBKK 9	PE 4	EBKK 4
PE 6	EBKK 6	PE 3	EBKK 3
PE 5	EBKK 5	PE 2	EBKK 2





Special  
Inserts

# COMPONENT HOLDERS

## INDIVIDUAL MODELED

In order to provide your individual components for a smooth automated production process, we produce high quality customized component crates of plastic – at lower cost for small quantities! This allows precise positioning of components as well as high repeatability in automation. Prices on request.

- Minimum wear
- high mechanical resistance



## COMPONENT HOLDERS

Article No.	Dimensions L x W x H	Up to 500 per unit	Up to 1.000 per unit	Up to 2.500 per unit	Up to 5.000 per unit	Up to 10.000 per unit
WT 3626	36 x 26 x max. 5	1,44 €	1,30 €	1,20 €	1,18 €	1,16 €
WT 5636	56 x 36 x max. 5	1,96 €	1,81 €	1,71 €	1,68 €	1,67 €
WZ 3626	tool for WT 3626 (per pcs.)					1.400 €
WZ 5636	tool for WT 5636 (per pcs.)					2.100 €

## INFORMATION

Article No.	WT 3626	WT 5636
<b>Material</b>		
Material: PS reclaim	Colour: black	Colour: black
initial thickness of the sheet material	2,0 mm	2,0 mm



## STORE YOUR GLASES AND COMPONENTS

The grid insert, especially constructed for our containers, just have to be placed on the bottom of the containers, whereas the top version has to be clicked into the open handles.

- Suitable for washing, storing and transporting glasses
- The robust dividing elements ensure a safe transport of the glasses
- Open design for good rinsing and drying results



Order now & save money!  
e.g.  
special inserts  
24 / 9,0 x 8,6 f. bottom  
Gef 24 u  
Price/Unit on pallet

Our best price  
from €

**3,<sup>68</sup>**

Special Inserts

### SPECIAL INSERTS FOR THE BASE SIZE 60 X 40 CM

Number of compartments / Dimensions L x W	Article No.	Units per carton	Price/Unit carton	Units per pallet	Price/Unit Palette
12 / 13,7 x 11,7 f. top	Gef 12 o	27	4,72 €	240	3,93 €
12 / 13,7 x 11,7 f. bottom	Gef 12 u	27	4,72 €	240	3,93 €
15 / 10,9 x 11,7 f. top	Gef 15 o	27	5,26 €	240	4,38 €
15 / 10,9 x 11,7 f. bottom	Gef 15 u	27	5,26 €	240	4,38 €
24 / 9,0 x 8,6 f. top	Gef 24 o	27	4,42 €	240	3,68 €
24 / 9,0 x 8,6 f. bottom	Gef 24 u	27	4,42 €	240	3,68 €
40 / 6,7 x 6,7 f. top	Gef 40 o	27	6,46 €	240	5,38 €
40 / 6,7 x 6,7 f. bottom	Gef 40 u	27	6,46 €	240	5,38 €

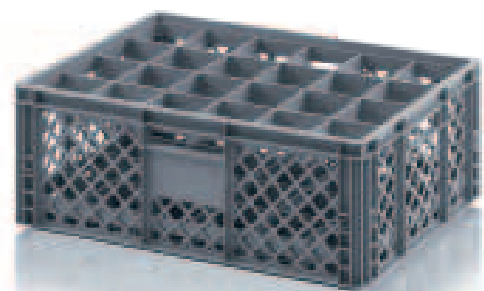
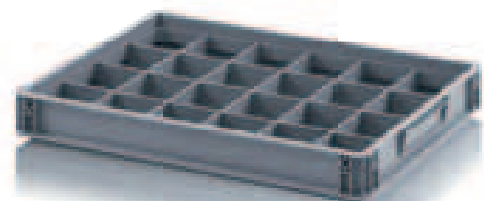

# DIVIDER CROSS

## FOR EURO CONTAINERS

The perfect solution if you want to divide your eurocontainers only transverse: A small insert on both long sides enables you to connect the transverse dividers easily, stable and save with the container. We produce your transverse divider inserts according to your requirements! For placing the order, just inform us how many dividers your system should have and how high you want it to be, like shown in the order example.



### DIVIDER CROSS

Article No.	Height	basic price	extra charge per divider
QT GEF 43 *Q*H	5 - 30 cm	30,00 €	5,00 €
QT GEF 64 *Q*H	5 - 40 cm	30,00 €	6,00 €
QT GEF 86 *Q*H	5 - 40 cm	30,00 €	12,00 €

\*) has to be completed with the quantity and height required.  
Order example: **QT GEF 435Q20H** is one **transverse divider system**, suitable for our **40 x 30 container**, with **5 dividers** and a **height of 20 cm**. Price: 55 €

# DIVIDER LENGTH

## FOR EURO CONTAINERS

The perfect solution if you want the divide your container only lengthwise: A small insert on both, short sides enables you to connect the longitudinal dividers easily, stable and save with the container. We produce your longitudinal inserts according to your requirements- To order the divides, just inform us how many dividers your system should have and how high you want it to be, like shown in the order example.



### DIVIDER LENGTH

Article No.	Height	basic price	extra charge per divider
LT GEF 43 *L*H	5 - 30 cm	30,00 €	6,00 €
LT GEF 64 *L*H	5 - 40 cm	30,00 €	9,00 €
LT GEF 86 *L*H	5 - 40 cm	30,00 €	18,00 €

\*) has to be completed with the quantity and height required.  
Order example: **LT GEF 43 5L20H** is one **longitudinal dividers insert**, suitable for our **40 x 30 container**, with **5 dividers** and a **height of 20 cm**. Price: 60 €

No matter, how many compartments and heights you want to divide your Euro containers: We produce customized solutions on request! The functional plug-in system is pre-milled to your exact specifications.

Please indicate in your order, quantity and height of transverse and longitudinal dividers (see example below)

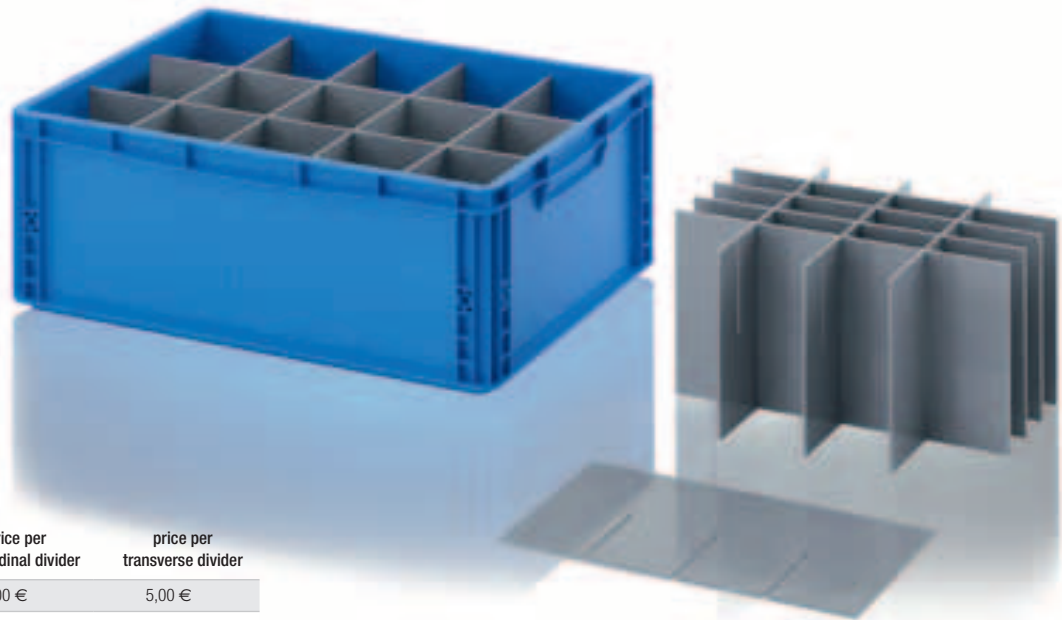

Special Inserts

### SPECIAL INSERTS

Article No.	Height	price per longitudinal divider	price per transverse divider
SGF 43 *L*Q*H	5 - 30 cm	6,00 €	5,00 €
SGF 64 *L*Q*H	5 - 40 cm	9,00 €	6,00 €
SGF 86 *L*Q*H	5 - 40 cm	18,00 €	12,00 €

\*) has to be completed with the quantity and height required.  
Order example: **SGF 43 5L2Q20H** is one **special insert**, suitable for our **40 x 30 containers**, with **5 longitudinal dividers**, **2 transverse dividers** and a **height of 20 cm**. Price: 40 €



Also in ESD-Version available.

## INTERMEDIATE PLATE / CUT

### SEPARATE IN LAYERS

If you like to create order inside your Euro containers, then insert one divider level more! The intermediate plate are tailored to the individual container base dimensions. On request we offer individual level-cuts according to your specifications.



Order now & save money!  
e.g.  
Intermediate plate  
56,5 x 36,5 cm  
ZP64  
Price/Unit on pallet

Our best price  
from €  
**8,55**

### INTERMEDIATE PLATE FOR EURO CONTAINERS

Dimensions L x W (cm)	Article No.	Colour	Units per carton	Price/Unit in carton	Units per pallet	Price/Unit on pallet
36,5 x 26,5	ZP43	silver grey	20	4,68 €	500	3,90 €
56,5 x 36,5	ZP64	silver grey	20	10,26 €	500	8,55 €
75,5 x 55,5	ZP86	silver grey	20	21,28 €	500	17,73 €
pro m <sup>2</sup>	Zm <sup>2</sup>	silver grey		50,00 €		



Also in ESD-Version available.

# INSERTABLE BINS FOR EURO CONTAINER 60 X 40 CM

## 2ND DIVISION LENGTH

The flexible solution for the subdivision of Euro containers: Insertable bins can be purchased individually and with the Euro containers bonded.

- The handgrip is easy to insert and to remove (by empty or full state)
- Stackable with a reinforced rim



Order now & save money!  
e.g.  
Insertable bins  
56,3 x 18,3 x 5 cm  
EK 2/50  
Price/Unit on pallet

Our best price

from €

**2,34**

### INSERTABLE BINS 2ND DIVISION LENGTH FOR EURO CONTAINER

Dimensions L x W x H (cm)	Article No.	Colour	Units per carton	Price/Unit in carton	Units per pallet	Price/Unit on pallet
56,3 x 18,3 x 5	EK 2/50	black	40	2,81 €	440	2,34 €
56,3 x 18,3 x 10	EK 2/100	black	20	2,97 €	220	2,48 €
56,3 x 18,3 x 15	EK 2/150	black	10	3,33 €	300	2,77 €

# INSERTABLE BINS FOR EURO CONTAINER 60 X 40 CM

## 4TH DIVISION



Order now & save money!  
e.g.  
Insertable bins  
28,2 x 18,3 x 5 cm  
EK 4/50  
Price/Unit on pallet

Our best price

from €

**1,80**

### INSERTABLE BINS 4TH DIVISION FOR EURO CONTAINER

Dimensions L x W x H (cm)	Article No.	Colour	Units per carton	Price/Unit in carton	Units per pallet	Price/Unit on pallet
28,2 x 18,3 x 5	EK 4/50	black	80	2,16 €	968	1,80 €
28,2 x 18,3 x 10	EK 4/100	black	40	2,25 €	440	1,88 €
28,2 x 18,3 x 15	EK 4/150	black	20	2,67 €	300	2,23 €



Special Inserts

Order now & save money!  
e.g.  
Insertable bins  
18,3 x 14,1 x 5 cm  
EK 8/50  
Price/Unit on pallet

Our best price  
from €  
**1,37**

### INSERTABLE BINS 8TH DIVISION FOR EURO CONTAINER

Dimensions L x W x H (cm)	Article No.	Colour	Units per carton	Price/Unit in carton	Units per pallet	Price/Unit on pallet
18,3 x 14,1 x 5	EK 8/50	black	168	1,64 €	1800	1,37 €
18,3 x 14,1 x 10	EK 8/100	black	84	1,72 €	880	1,44 €
18,3 x 14,1 x 15	EK 8/150	black	42	1,98 €	630	1,65 €

# INSERTABLE BINS FOR EURO CONTAINER 40 X 30 CM

## 2ND DIVISION CROSS



Order now & save money!  
e.g.  
Insertable bins  
26,6 x 18,4 x 5 cm  
EK 2/50 43  
Price/Unit on pallet

Our best price  
from €  
**1,80**

### INSERTABLE BINS 2ND DIVISION CROSS FOR EURO CONTAINER

Dimensions L x W x H (cm)	Article No.	Colour	Units per carton	Price/Unit in carton	Units per pallet	Price/Unit on pallet
26,6 x 18,4 x 5	EK 2/50 43	black	80	2,16 €	1012	1,80 €
26,6 x 18,4 x 10	EK 2/100 43	black	40	2,25 €	440	1,88 €
26,6 x 18,4 x 15	EK 2/150 43	black	20	2,67 €	300	2,23 €



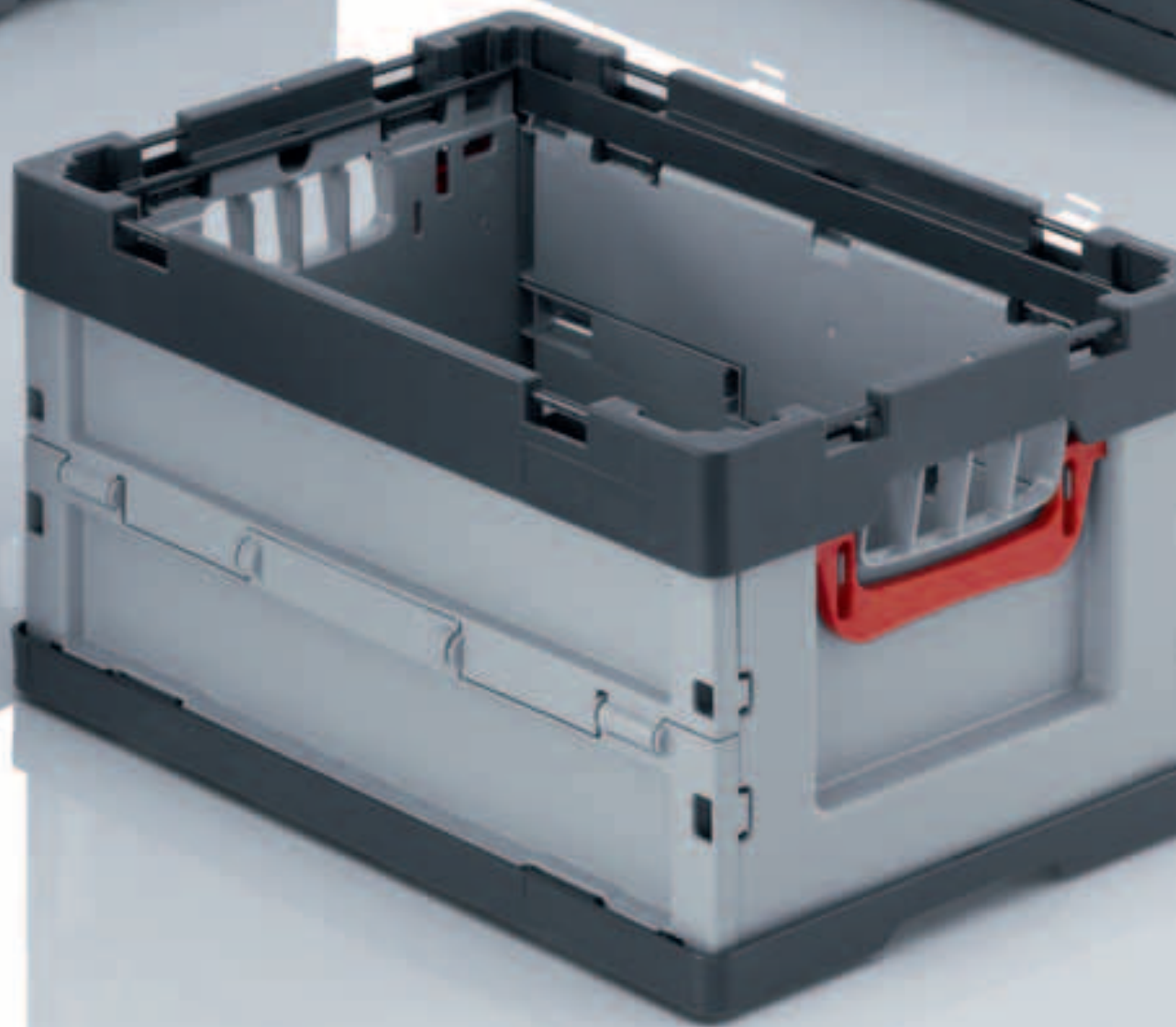
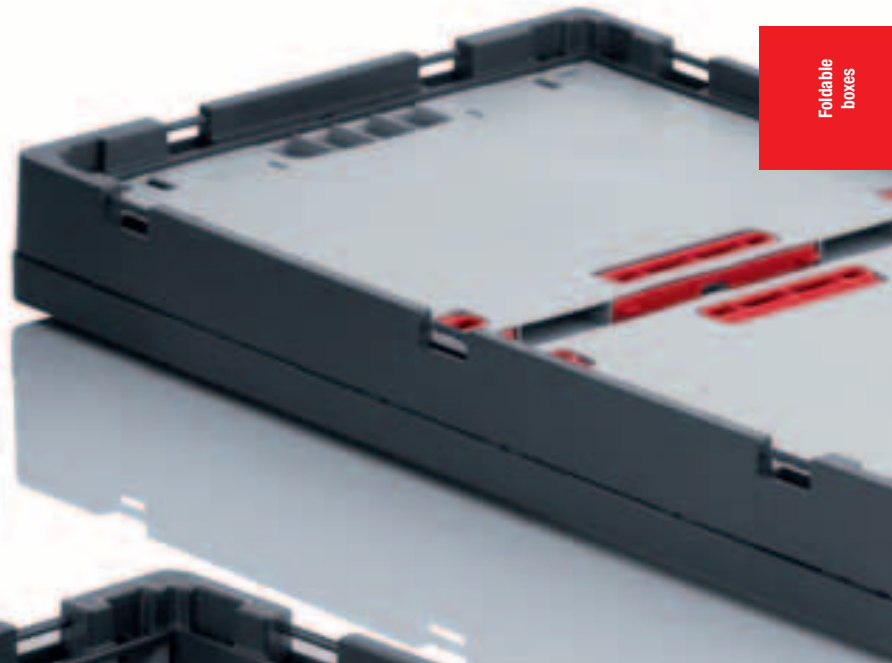

Foldable  
Boxes

## SPACE SAVERS

The collapsible and foldable containers by AUER Packaging can be used in a variety of applications. They are space-saving, extremely cost effective and compatible with other re-usable packaging systems.

Our containers are light, and at the same time very stable, stackable and can be quickly and simple opened up and folded down.



- Secure, quick and simple to fold
- High reduction in volume (up to 82%)
- Ideal box for transports and consignment
- Simple and robust folding mechanism
- Easy opening and closing
- Sealable (only with lid)



**SPECIAL COLOURS**  
Available in all RAL-colours for an additional surcharge (P. 100)



Order now & save money!  
e.g.:  
60 x 40 x 32 cm  
FB 64/32  
Price/Unit on pallet

Our best price  
from €

**11,62**

### FOLDABLE BOXES WITHOUT LIDS

Dimensions L x W x H (cm)	Article No.	Colour	Units per carton	Price/Unit in carton	Units per pallet	Price/Unit on pallet
40 x 30 x 22	FB 43/22	silver grey	10	9,41 €	200	7,84 €
40 x 30 x 27	FB 43/27	silver grey	10	9,66 €	200	8,05 €
40 x 30 x 32	FB 43/32	silver grey	10	9,92 €	200	8,26 €
60 x 40 x 22	FB 64/22	silver grey	5	12,43 €	100	10,36 €
60 x 40 x 27	FB 64/27	silver grey	5	13,19 €	100	10,99 €
60 x 40 x 32	FB 64/32	silver grey	5	13,95 €	100	11,62 €
60 x 40 x 42	FB 64/42	silver grey	5	16,74 €	100	13,95 €
80 x 60 x 44,5	FB 86/445	silver grey	3	30,78 €	50	25,65 €





Foldable Boxes



Order now & save money!  
e.g.:  
60 x 40 x 32 cm  
FBD 64/32  
Price/Unit on pallet

Our best price  
from €

**13,64**

**AVAILABLE UP FROM 1 PIECE!**  
No minimum purchase order. Excl. VAT; The per-pallet price is only applicable for complete pallets.



### FOLDABLE BOXES WITH LIDS

Dimensions L x W x H (cm)	Article No.	Colour	Units per carton	Price/Unit in carton	Units per pallet	Price/Unit on pallet
40 x 30 x 22	FBD 43/22	silver grey	10	12,01 €	200	10,01 €
40 x 30 x 27	FBD 43/27	silver grey	10	12,26 €	200	10,22 €
40 x 30 x 32	FBD 43/32	silver grey	10	12,52 €	200	10,43 €
60 x 40 x 22	FBD 64/22	silver grey	5	14,85 €	100	12,37 €
60 x 40 x 27	FBD 64/27	silver grey	5	15,61 €	100	13,01 €
60 x 40 x 32	FBD 64/32	silver grey	5	16,37 €	100	13,64 €
60 x 40 x 42	FBD 64/42	silver grey	5	19,16 €	100	15,97 €
80 x 60 x 44,5	FBD 86/445	silver grey	3	38,54 €	50	32,12 €
Seal	PB	black		0,20 €		





Reusable  
containers

# REUSABLE CONTAINERS

## ALL-ROUND STORAGE AID

Flexibility is the top priority in storage and transport. When empty, AUER reusable containers can be stacked into one another to save space. In normal position, the optional frames allow the containers to be stacked into one another, and when in raised position they make it

possible to vertically stack loaded containers even without lids. Thanks to their robust design, they allow for high stack height. The recess in the lids of the reusable containers offer a high stability.

- Saves volume during empty transport
- Up to 75% less empty volume



Order now & save money!  
e.g.  
30 x 20 x 17 cm  
MBB 3217  
Preis/St. auf Palette

Our best price  
from €  
**3,99** (special offer)

### REUSABLE CONTAINERS

Dimensions L x W x H (cm)	Article No.	Colour	Units per carton	Price/Unit in carton	Units per pallet	Price/Unit on pallet
30 x 20 x 17	MB 3217	blue	50	3,66 €	800	3,05 €
40 x 30 x 22	MB 4322	blue	26	4,24 €	400	3,53 €
40 x 30 x 27	MB 4327	blue	23	4,49 €	300	3,74 €
40 x 30 x 32	MB 4332	blue	20	4,75 €	240	3,95 €
60 x 40 x 17	MB 6417	blue	17	7,50 €	200	6,25 €
60 x 40 x 22	MB 6422	blue	15	8,01 €	200	6,68 €
60 x 40 x 27	MB 6427	blue	12	8,52 €	150	7,10 €
60 x 40 x 32	MB 6432	blue	11	9,02 €	120	7,52 €
60 x 40 x 42	MB 6442	blue	6	10,04 €	90	8,37 €

### REUSABLE CONTAINERS WITH STACKING FRAMES

Dimensions L x W x H (cm)	Article No.	Colour	Units per carton	Price/Unit in carton	Units per pallet	Price/Unit on pallet
30 x 20 x 17	MBB 3217	blue	50	4,79 €	560	3,99 €
40 x 30 x 22	MBB 4322	blue	26	5,03 €	400	4,19 €
40 x 30 x 27	MBB 4327	blue	23	5,29 €	300	4,40 €
40 x 30 x 32	MBB 4332	blue	20	5,54 €	240	4,62 €
60 x 40 x 17	MBB 6417	blue	17	8,66 €	200	7,21 €
60 x 40 x 22	MBB 6422	blue	15	9,16 €	200	7,64 €
60 x 40 x 27	MBB 6427	blue	12	9,67 €	150	8,06 €
60 x 40 x 32	MBB 6432	blue	11	10,18 €	120	8,48 €
60 x 40 x 42	MBB 6442	blue	6	11,19 €	90	9,33 €



Reusable  
containers

Order now & save money!  
e.g.  
60 x 40 x 34 cm  
MBD 6432  
Price/Unit on pallet

Our best price  
from €

**10,92**



### REUSABLE CONTAINERS WITH LIDS

Dimensions L x W x H (cm)	Article No.	Colour	Units per carton	Price/Unit in carton	Units per pallet	Price/Unit on pallet
30 x 20 x 19	MBD 3217	blue	36	6,72 €	300	5,60 €
40 x 30 x 24	MBD 4322	blue	12	7,20 €	168	6,00 €
40 x 30 x 29	MBD 4327	blue	12	7,45 €	138	6,21 €
40 x 30 x 34	MBD 4332	blue	6	7,71 €	114	6,42 €
60 x 40 x 19	MBD 6417	blue	9	11,59 €	112	9,65 €
60 x 40 x 24	MBD 6422	blue	6	12,09 €	112	10,08 €
60 x 40 x 29	MBD 6427	blue	6	12,60 €	92	10,50 €
60 x 40 x 34	MBD 6432	blue	3	13,11 €	76	10,92 €
60 x 40 x 44	MBD 6442	blue	3	14,12 €	60	11,77 €
Seal	PB	black				0,20 €

When complete cartons are ordered, lids will be delivered for self-assembling



### REUSABLE CONTAINERS

Dimensions L x W x H (cm)	Article No.	Colour	Model	Units per carton	Price/Unit in carton	Units per pallet	Price/Unit on pallet
80 x 60 x 32	MB 8632	blue		1	19,27 €	40	16,06 €
80 x 60 x 42	MB 8632K	blue	with 2 skids	1	34,95 €	26	29,12 €
80 x 60 x 42	MB 8642	blue		1	22,31 €	40	18,59 €
80 x 60 x 52	MB 8642K	blue	with 2 skids	1	38,38 €	24	31,98 €

### REUSABLE CONTAINERS WITH STACKING FRAMES

Dimensions L x W x H (cm)	Article No.	Colour	Model	Units per carton	Price/Unit in carton	Units per pallet	Price/Unit on pallet
80 x 60 x 32	MBB 8632	blue		1	21,19 €	40	17,65 €
80 x 60 x 42	MBB 8632K	blue	with 2 skids	1	36,86 €	26	30,72 €
80 x 60 x 42	MBB 8642	blue		1	24,23 €	40	20,19 €
80 x 60 x 52	MBB 8642K	blue	with 2 skids	1	40,30 €	24	33,58 €

The huge Auer reusable containers, with the size 80 x 60, can also be stacked space saving into each other. Optionally available stacking frames enable you to stack the containers into each other when the stacking frames are in home position. When flipped out, the boxes can be stacked onto each other - also without lids. Due to their stable design, large stacking heights are possible. Further available equip-

ments are hinged lids and skids. The hinged lid, with its recess, offers high stacking stability. The skids offer a rational handling with lift trucks and fork lifters.

- saves volume when transported empty
- up to 75% less empty volume

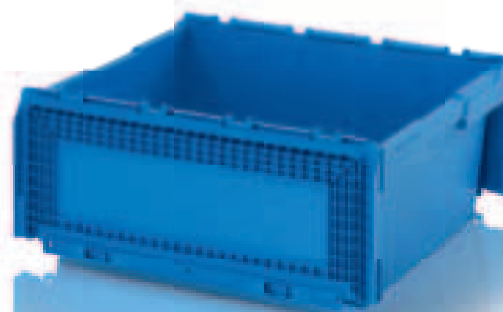
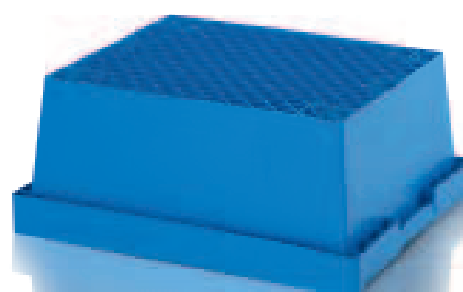

## REUSABLE CONTAINERS WITH LIDS

Dimensions L x W x H (cm)	Article No.	Colour	Model	Units per carton	Price/Unit in carton	Units per pallet	Price/Unit on pallet
80 x 60 x 34	MBD 8632	blue		1	27,94 €	40	23,28 €
80 x 60 x 44	MBD 8632K	blue	with 2 skids	1	43,63 €	26	36,36 €
80 x 60 x 44	MBD 8642	blue		1	30,98 €	26	25,82 €
80 x 60 x 54	MBD 8642K	blue	with 2 skids	1	47,04 €	24	39,20 €
Seal	PB	black					0,20 €

When complete cartons are ordered, lids will be delivered for self-assembling

## SINGLE WHEEL FOR SELF-ASSEMBLY

Article No.	Model	Price/Unit
MBRA	polyamide-steering wheel	7,50 €

You find more wheel types on our online shop

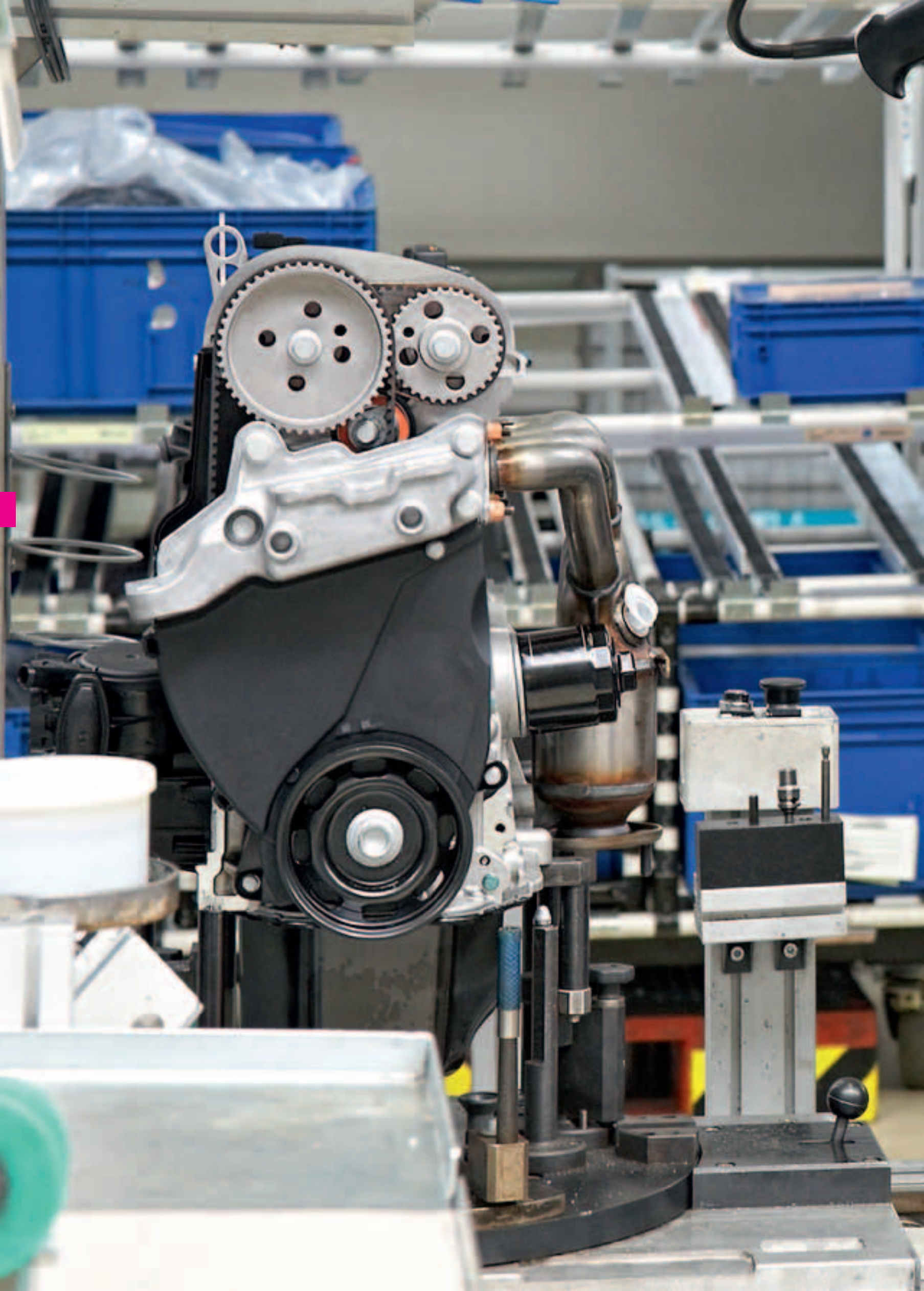



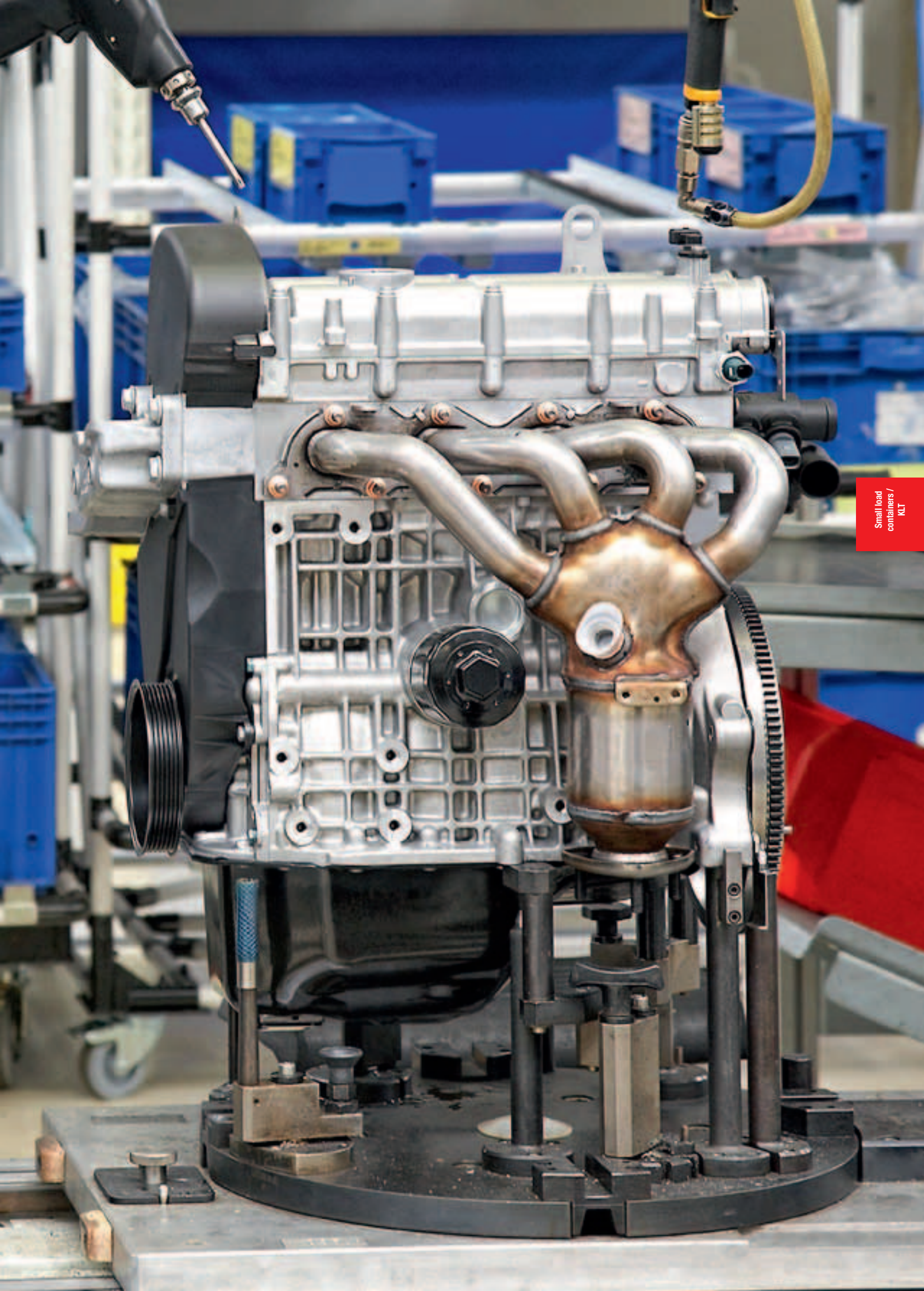

Small load  
containers /  
KLT

# R-KLT BOXES ACCORDING THE VDA-4500 STANDARD

## FIT SEAMLESSLY INTO EACH OTHER

Our R-KLT mini-load containers( approximately available in autumn 2012) are fully conforming to the standards of the Association of Automotive Industry (VDA). They fit perfectly for highly automated production processes and are equipped with a sturdy base ribbing. Stable impact surfaces on the front and the sides allow the use in mini-load systems; lifting slots for vertical retrieval and special holes for the fixing of lid sealings. Perfectly usable for manual handling due to their ergonomic grips at the front walls and their practical support grips on the side walls.

The mini-load containers are also available in foldable version. (Version- F-KLT)

- Conform to VDA-standards
- Material 100% Polypropylene
- Resistant to most oils, acids and alkalis
- Quiet running on conveyors
- Withstands temperature from -20 to +100 degrees Celsius
- Fully recyclable

- Easy cleaning due to smooth internal walls
- Integrated lid slots
- Barcode fixing area



Also in ESD-Version available.

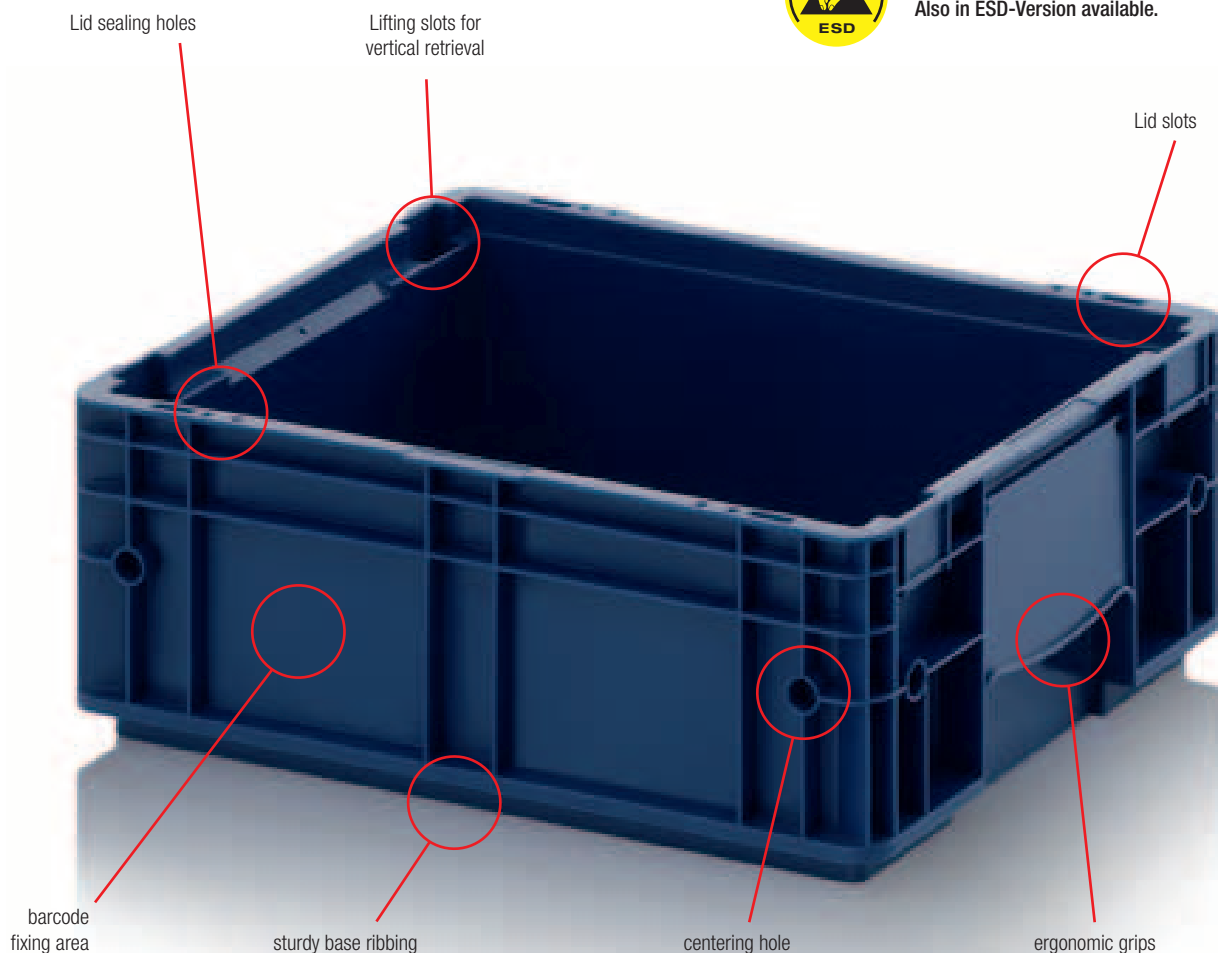

The lids for the R-KLT Series according to the VDA standards are also made of 100 % PP and seal the containers dust-proof. The containers can also be stacked with lids.

### R-KLT BOXES ACCORDING THE VDA-4500 STANDARD

Dimensions L x W x H (cm)	internal dimensions on the bottom L x W x useable height (cm)	Article No.	Colour	Contents (Litre)
30 x 20 x 15	24,3 x 16,2 x 12,95	R-KLT 3215	RAL 5003	5,3
40 x 30 x 15	34,6 x 26,5 x 10,95	R-KLT 4315	RAL 5003	10,0
40 x 30 x 18	34,6 x 26,5 x 13,59	R-KLT 4318	RAL 5003	12,5
40 x 30 x 22	34,6 x 26,5 x 17,6	R-KLT 4322	RAL 5003	16,1
40 x 30 x 29	34,6 x 26,5 x 24,20	R-KLT 4329	RAL 5003	22,0
60 x 40 x 15	54,4 x 36,4 x 10,95	R-KLT 6415	RAL 5003	22,0
60 x 40 x 18	54,4 x 36,4 x 13,6	R-KLT 6418	RAL 5003	26,9
60 x 40 x 22	54,4 x 36,4 x 17,5	R-KLT 6422	RAL 5003	34,6
60 x 40 x 29	54,4 x 36,4 x 24,2	R-KLT 6429	RAL 5003	48,0

### LIDS ACCORDING TO VDA STANDARD 4500

Article No.	suitable for containers (cm)	Colour
R-KLT-D 39	30 x 20	RAL 5003
R-KLT-D 49	40 x 30	RAL 5003
R-KLT-D 69	60 x 40	RAL 5003

### FOLDABLE KLT SERIES CONFORMING VDA 4500 STANDARDS

Dimensions L x W x H (cm)	internal dimensions on the bottom L x W x useable height (cm)	Article No.	Model	Colour	Contents (Litre)
60 x 40 x 28	53,4 x 35,7 x 25,7	F-KLT 6410	sturdy base ribbing	RAL 5005	46,0

## MATERIAL FLOW CONFORMING TO THE VDA STANDARD

Our RL-KLT containers with a smooth sub-floor and waterdrainage holes in the base (approximately available in autumn 2012) can ideally be used for areas where liquids (e.g. of cleaning processes, or individual production stages) shall be drained off. Stable impact surfaces on the front and the sides allow the use in mini-load system; lifting slots the vertical retrieval and special holes the fixing of lid sealings. Perfectly usable for manual handling due to their ergonomic grips at the front walls and their practical support grips on the side walls.

- According to VDA 4500 (only RL-KLT)
- Waterdrainage holes in the base can be supplied according to VDS classification directive BG 4.3.
- Material 100 % Polypropylene
- Resistant to most oil, acids and alkalis
- Quite running on conveyors, when used correctly
- Retains its stability at temperatures from -20° to +100° C
- Fully recyclable
- Easy cleaning due to smooth internal walls
- Integrated lid slots
- Barcode fixing area



Also in ESD-Version available.



Smooth sub-floor with waterdraiange holes

Small load containers / KLT

### RL-KLT CONFORMING VDA 4500 STANDARDS

Dimensions L x W x H (cm)	internal dimensions on the bottom L x W x useable height (cm)	Article No.	Colour	Contents (Litre)
30 x 20 x 14,7	24,3 x 16,2 x 12,95	RL-KLT 3147	RAL 5005	5,3
40 x 30 x 14,7	34,5 x 26 x 12,95	RL-KLT 4147	RAL 5005	11,8
40 x 30 x 17,4	34,5 x 26 x 14,75	RL-KLT 4174*	RAL 5005	13,2
40 x 30 x 21,3	34,5 x 26 x 21,3	RL-KLT 4213*	RAL 5005	17,6
40 x 30 x 28	34,5 x 26 x 26,2	RL-KLT 4280	RAL 5005	24,1
60 x 40 x 14,7	54,4 x 35,9 x 12,95	RL-KLT 6147	RAL 5005	25,0
60 x 40 x 17,4	54,4 x 35,9 x 15,6	RL-KLT 6174*	RAL 5005	30,4
60 x 40 x 21,3	54,4 x 35,9 x 19,5	RL-KLT 6213*	RAL 5005	38,1
60 x 40 x 28	54,4 x 35,9 x 26,2	RL-KLT 6280	RAL 5005	51,9

\* without VDA-recommendation

### L-KLT CONFORMING VDA 4500 STANDARDS

Dimensions L x W x H (cm)	internal dimensions on the bottom L x W x useable height (cm)	Article No.	Colour	Contents (Litre)
80 x 60 x 21	73,9 x 55,6 x 19,2	L-KLT 8210 g	signal grey	79,0

### FOLDABLE KLT SERIES CONFORMING VDA 4500 STANDARDS

Dimensions L x W x H (cm)	internal dimensions on the bottom L x W x useable height (cm)	Article No.	Model	Colour	Contents (Litre)
60 x 40 x 28	53,4 x 35,7 x 27,7	F-KLT 6410 G	smooth underbody	RAL 5005	49,5

Our RL-KLT lids are also made of 100 % PP and seal the containers dust-proof. The containers are also stackable with lids.

### LIDS ACCORDING TO VDA STANDARD 4500

Article No.	suitable for containers (cm)	Colour
RL-KLT-D 35	30 x 20	RAL 5005
RL-KLT-D 45	40 x 30	RAL 5005
RL-KLT-D 65	60 x 40	RAL 5005



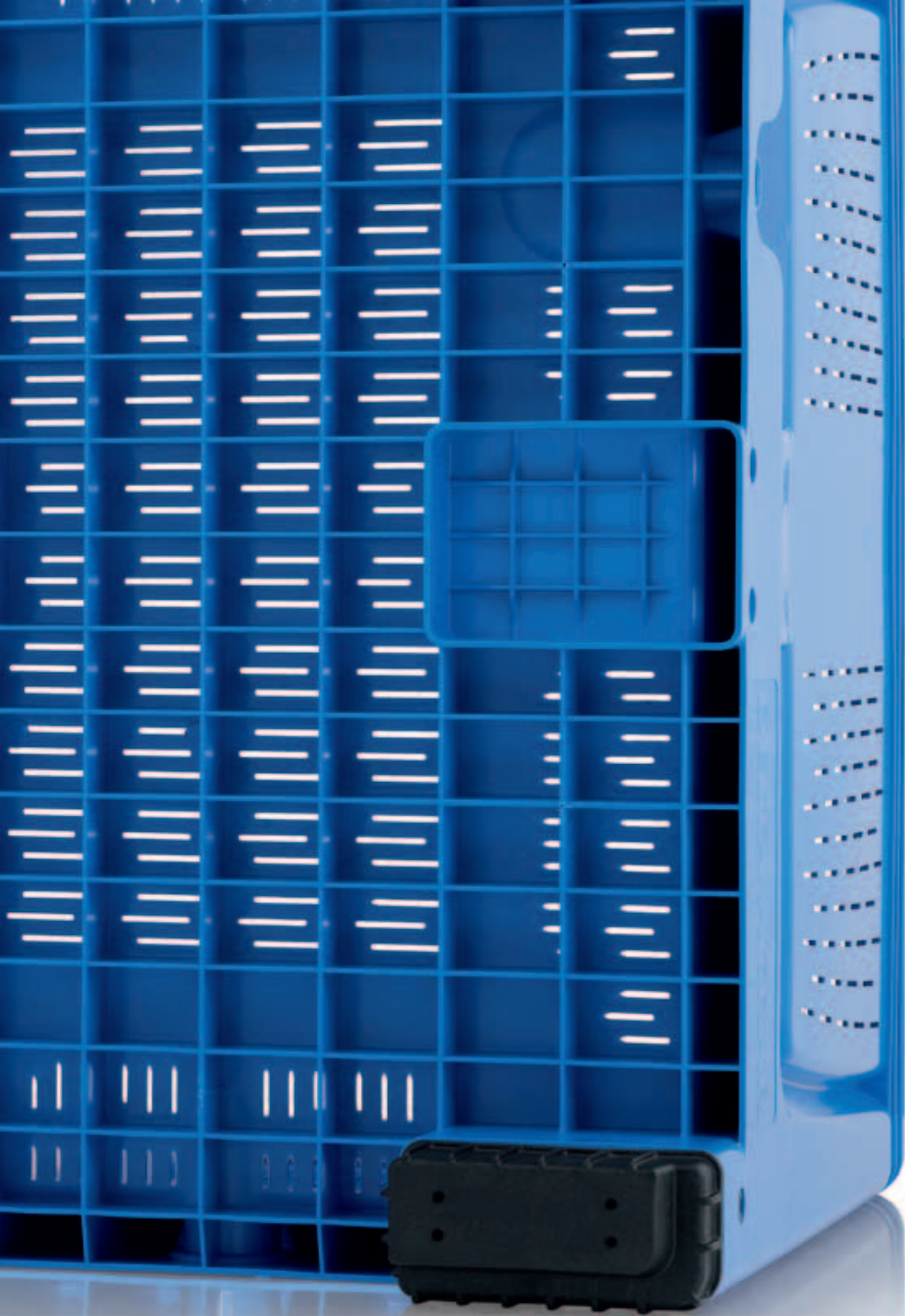

# BIG BOXES SOLID

## ROBUST IN LARGE SIZE

The containers are made of a robust, scratch-resistant plastic material. Smooth inner and outer walls ensure easy cleaning. Standardized dimensions (Euro 1.200 x 800 mm or ISO 1.200 x 1.000 mm) ensure smooth operation in storage and transport processes.

- Also stackable with lid
- Superimposed load 4 tonnes
- ISO and EURO dimensions
- available with feet, skids or wheels



BBG 1208+K UN approval:  
(u 11H2N/ \*.\*/H/AUER  
01-09/2700/535 n)  
BBG 1210+K UN approval:  
(u 11H2N/ \*.\*/H/AUER  
02-09/3780/700 n)  
\*= Month and year of  
manufacture

**SPECIAL COLOURS**  
Available in all RAL-colours for  
an additional surcharge (P. 100)



Order now & save money!  
e.g.:  
Enclosed Big Box  
120 x 80 x 79 cm  
BBG 1208

Our best price  
from €

**89,<sup>95</sup>**

### BIG BOXES SOLID

Dimensions L x W x H (cm)	Article No.	Colour	Model	Price for single unit	Units per storing position	Price/Unit per storing position
120 x 80 x 79	BBG 1208	silver grey	with 4 feet	116,94 €	3	89,95 €
120 x 80 x 79	BBG 1208K	silver grey	with 3 skids	129,94 €	3	99,95 €
120 x 100 x 79	BBG 1210	silver grey	with 4 feet	124,74 €	4	95,95 €
120 x 100 x 79	BBG 1210K	silver grey	with 3 skids	137,74 €	4	105,95 €
120 x 100 x 100	MBG 1210	moss green	with 4 feet	168,94 €	2	129,95 €
120 x 100 x 100	MBG 1210K	moss green	with 3 skids	181,94 €	2	139,95 €



Lids for Big Boxes  
Extremely sturdy and stackable!



### LIDS FOR BIG BOXES

Dimensions L x W (cm)	Article No.	Colour	Price for single unit	Units per storing position	Price/Unit per storing position
120 x 80	DE 1208	silver grey	38,74 €	50	32,28 €
120 x 100	DE 1210	silver grey	40,30 €	50	33,58 €



**AVAILABLE UP FROM 1 PIECE!**  
No minimum purchase order. Excl. VAT; The per-pallet price is only applicable for complete pallets.

Big Boxes



## ACCESSORIES

Article No.	Model	Colour	Price/Unit
SST-1	Screw cap 1" suitable for Big Boxes	black	5,00 €
SST-2	Screw cap 2" suitable for Big Boxes	white	5,00 €
V2	Outlet valve 2" suitable for Big Boxes	white	15,00 €
GS-K1	Cut a screw thread 1" width Big Box		10,00 €
GS-L1	Cut a screw thread 1" length Big Box		10,00 €
GS-K2	Cut a screw thread 2" width Big Box		10,00 €
GS-L2	Cut a screw thread 2" length Big Box		10,00 €

## SINGLE WHEEL FOR SELF-ASSEMBLY

Article No.	Model	Price/Unit
MRO4022	Rubber steering wheels for foldable and non-foldable Big Boxes	7,50 €
MRO4065	Rubber steering wheels with brakes for foldable and non-foldable Big Boxes	8,75 €

You find more wheel types on our online shop

# BIG BOXES PERFORATED

## ROBUST IN LARGE SIZE

The containers are made of a robust, scratch-resistant plastic material. Smooth inner and outer walls ensure easy cleaning. Standardized dimensions (ISO 1.200 x 1.000 mm) ensure smooth operation in storage and transport processes.

- Also stackable with lid
- Superimposed load 4 tonnes
- available with feet, skids or wheels

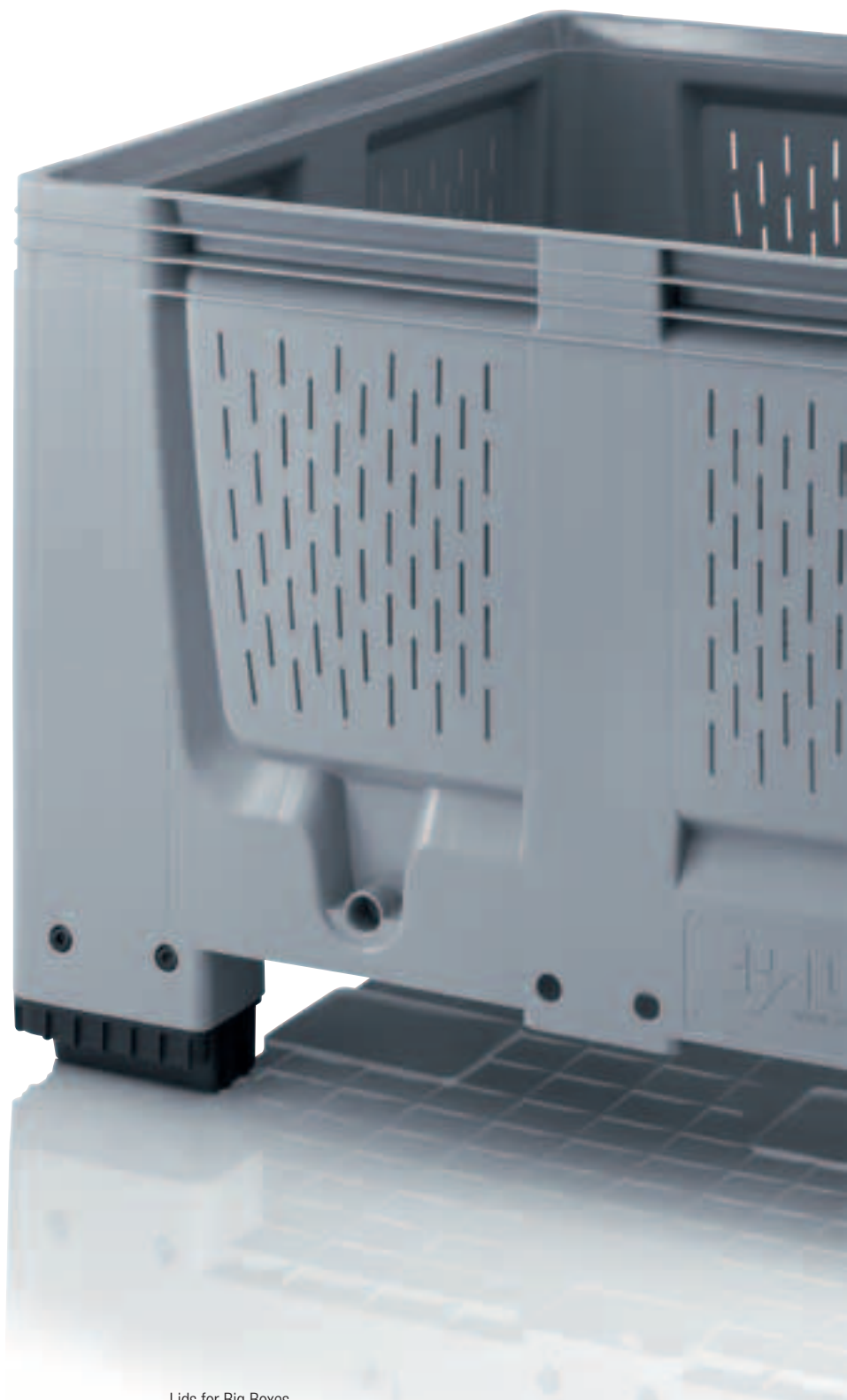

### SPECIAL COLOURS

Available in all RAL-colours for an additional surcharge (P. 100)



Order now & save money!  
e.g.:  
Big Box with ventilation slots  
120 x 100 x 79 cm  
BBO 1210

Our best price  
from €

# 95,95

Lids for Big Boxes  
Extremely sturdy and stackable!

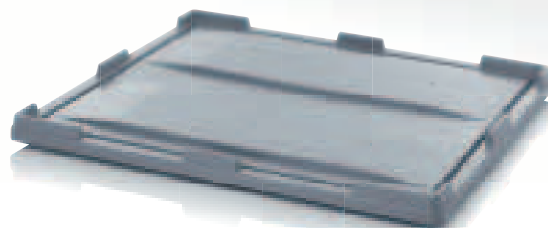

### BIG BOXES PERFORATED

Dimensions L x W x H (cm)	Article No.	Colour	Model	Price for single unit	Units per storing position	Price/Unit per storing position
120 x 100 x 79	BBO 1210	silver grey	with 4 feet	124,74 €	4	95,95 €
120 x 100 x 79	BBO 1210K	silver grey	with 3 skids	137,74 €	4	105,95 €
120 x 100 x 100	MBO 1210	silver grey	with 4 feet	168,94 €	2	129,95 €
120 x 100 x 100	MBO 1210K	silver grey	with 3 skids	181,94 €	2	139,95 €

### LIDS FOR BIG BOXES

Dimensions L x W (cm)	Article No.	Colour	Price for single unit	Units per storing position	Price/Unit per storing position
120 x 80	DE 1208	silver grey	38,74 €	50	32,28 €
120 x 100	DE 1210	silver grey	40,30 €	50	33,58 €





**AVAILABLE UP FROM 1 PIECE!**  
 No minimum purchase order. Excl. VAT; The per-pallet price is only applicable for complete pallets.

Big Boxes



### SINGLE WHEEL FOR SELF-ASSEMBLY

Article No.	Model	Price/Unit
MRO4022	Rubber steering wheels for foldable and non-foldable Big Boxes	7,50 €
MRO4065	Rubber steering wheels with brakes for foldable and non-foldable Big Boxes	8,75 €

You find more wheel types on our online shop

# CLOSING SYSTEM

## FOR BIG BOXES

Secure valuable and sensitive goods against unauthorized manipulation! With our closing system are your Big boxes on the safe side.

The closing sets come pre-mounted.

Please note:

- hinges are only fixed on the long sides of the boxes
- if a container is equipped with hinges, the pad locks should only be fixed opposite the hinges.

### Toggle-type fastener SV

to secure hold the lid and close the container  
(1 unit is required per box)  
Images with item 41132 2

### Locking hinge SA

- middle adjustment of 95°
- very stable  
(per container are required 2 units)



### CLOSING SYSTEM SA/SV FOR BIG BOXES

Article No.	Model	Price/Unit
SV	Toggle-type fastener*	25,00 €
SA	Locking hinge*	25,00 €
41132 2	no fixed padlock*	3,91 €
[Article No. of container] SASV	2 fixing hinges, 1 fastener	+75,00 €

\*) available with appropriate fasteners for single units

**Locking hinge SA**

- middle adjustment of 95°
  - very stable
- (per container are required 2 units)

**Padlock with eyebolt SC**

simultaneous locking lock

Scope of supply for SC Big boxes

- 1 padlock
  - 1 eyebolt
  - 1 locking nut
  - 1 standard nut
- (per container are required 4 units)

**CLOSING SYSTEM SC/SA FOR BIG BOXES**

Article No.	Model	Price/Unit
SC	Padlock with eyebolt*	10,00 €
SA	Locking hinge*	25,00 €
[Article No. of container] SASC	2 fixing hinges, 2 padlocks with eyebolts	+70,00 €
[Article No. of container] SC	4 padlocks with eyebolts	+40,00 €

\*) available with appropriate fasteners for single units





# OUR POSSIBILITIES OF COMBINATION

## YOUR TAILOR-MADE BOXES!

You would like to get your foldable bigbox with different walls - e.g. one side with a flap, another one perforated and the third one closed? No problem, we will assemble your bigbox as desired! The best of all is: you will not have to pay any extra charge for this packing - all components will be charged with the usual list prices.

■ side wall closed





■ side wall perforated

■ front wall closed with flaps

Collapsible  
Big Boxes

# COLLAPSIBLE BIG BOXES WITH ACCESS DOORS

## TRANSPORT ERGONOMICS

Collapsible Big Boxes offer cost advantages due to a reduced volume for return transports

- Easy access, with drop down doors available on any or all sides
- stackable – even with lid
- optional label holder



### SPECIAL COLOURS

Available in all RAL-colours for an additional surcharge (P. 100)



### AVAILABLE UP FROM 1 PIECE!

No minimum purchase order. Excl. VAT; The per-pallet price is only applicable for complete pallets.



Order now & save money!

e.g.:

Collapsible Big Box  
with access doors  
120 x 80 x 100 cm  
KLK 1208

Our best price  
from €

# 139,<sup>95</sup>

## COLLAPSIBLE BIG BOXES WITH ACCESS DOORS

Dimensions L x W x H (cm)	Article No.	Colour	Model	Price for single unit	Units per storing position	Price/Unit per storing position
120 x 80 x 100	KLK 1208	silver grey	with 4 feet	167,94 €	5	139,95 €
120 x 80 x 100	KLK 1208K	silver grey	with 3 skids	179,94 €	5	149,95 €
120 x 100 x 100	KLK 1210	silver grey	with 4 feet	179,94 €	5	149,95 €
120 x 100 x 100	KLK 1210K	silver grey	with 3 skids	191,94 €	5	159,95 €
<b>Label holder</b>						
25 x 15	ETA5	red	(for labelling container contents)			1,00 €

Lids for Big Boxes  
Extremely sturdy and stackable!

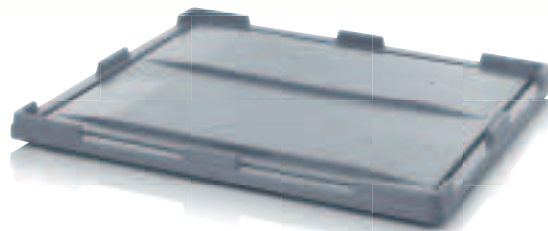

## LIDS FOR BIG BOXES

Dimensions L x W (cm)	Article No.	Colour	Price for single unit	Units per storing position	Price/Unit per storing position
120 x 80	DE 1208	silver grey	38,74 €	50	32,28 €
120 x 100	DE 1210	silver grey	40,30 €	50	33,58 €



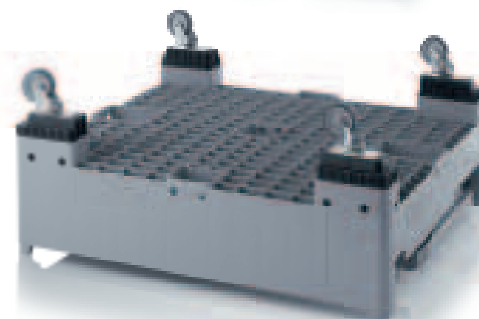
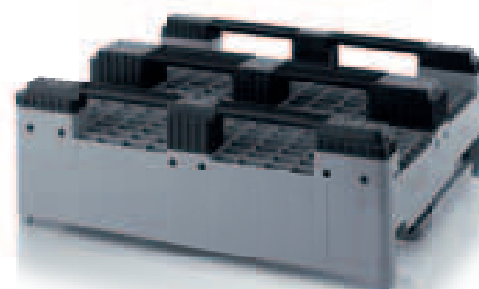
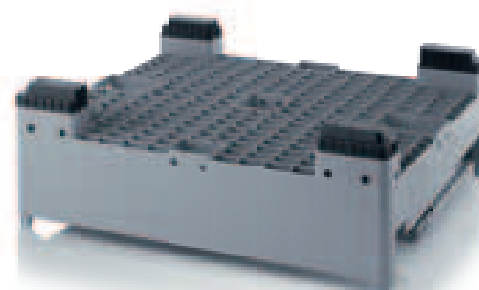

Collapsible  
Big Boxes

## SINGLE WHEEL FOR SELF-ASSEMBLY

Article No.	Model	Price/Unit
MR04022	Rubber steering wheels for foldable and non-foldable Big Boxes	7,50 €
MR04065	Rubber steering wheels with brakes for foldable and non-foldable Big Boxes	8,75 €

You find more wheel types on our online shop

# COLLAPSIBLE BIG BOXES CLOSED

## UNFOLD TO FULL EXTENT

The maximum volume of the bulk containers saves time and money in transport, handling and storage.

- volume optimized sides
- space-saving when empty
- low tare
- easy to clean



### SPECIAL COLOURS

Available in all RAL-colours for an additional surcharge (P. 100)



### AVAILABLE UP FROM 1 PIECE!

No minimum purchase order. Excl. VAT; The per-pallet price is only applicable for complete pallets.

Order now & save money!  
e.g.  
Big Box closed  
120 x 80 x 100 cm  
KLG 1208

Our best price  
from €

# 119,95

### FOLDABLE BULK CONTAINER WITH CLOSED BASE AND SIDES

Dimensions L x W x H (cm)	Article No.	Colour	Model	Price for single unit	Units per storing position	Price/Unit per storing position
120 x 80 x 100	KLG 1208	silver grey	with 4 feet	143,94 €	5	119,95 €
120 x 80 x 100	KLG 1208K	silver grey	with 3 skids	155,94 €	5	129,95 €
120 x 100 x 100	KLG 1210	silver grey	with 4 feet	167,94 €	5	139,95 €
120 x 100 x 100	KLG 1210K	silver grey	with 3 skids	179,94 €	5	149,95 €
120 x 100 x 79	KSG 1210	silver grey	with 4 feet	155,94 €	5	129,95 €
120 x 100 x 79	KSG 1210K	silver grey	with 3 skids	167,94 €	5	139,95 €



Lids for Big Boxes  
Extremely sturdy and stackable!

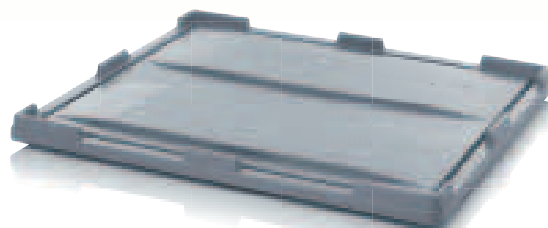

### LIDS FOR BIG BOXES

Dimensions L x W (cm)	Article No.	Colour	Price for single unit	Units per storing position	Price/Unit per storing position
120 x 80	DE 1208	silver grey	38,74 €	50	32,28 €
120 x 100	DE 1210	silver grey	40,30 €	50	33,58 €

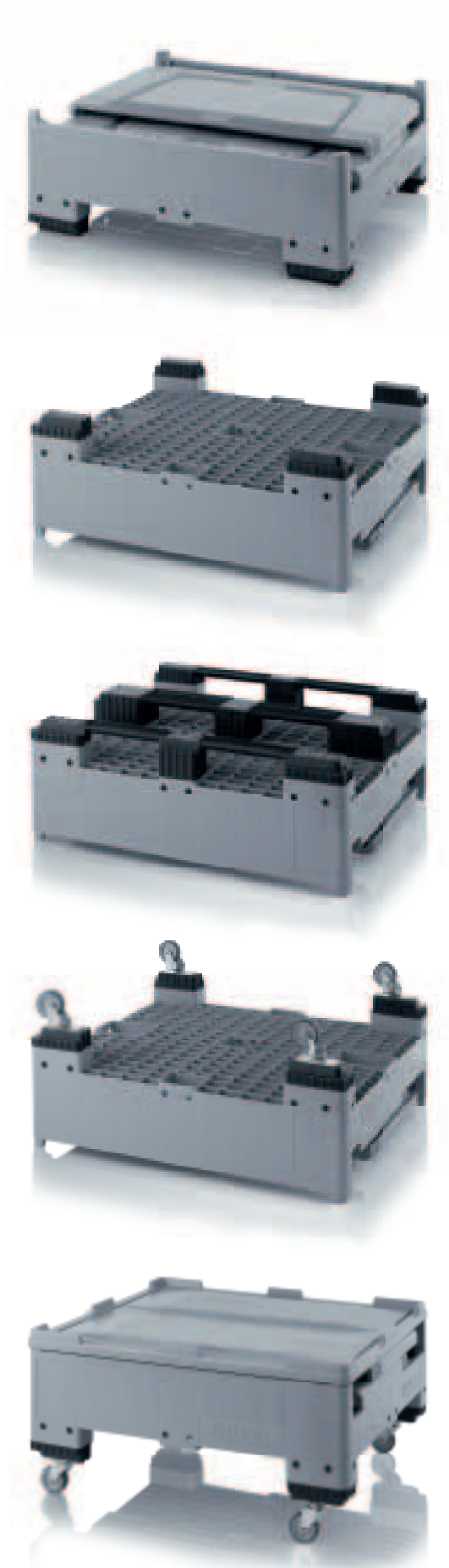

Collapsible  
Big Boxes

## SINGLE WHEEL FOR SELF-ASSEMBLY

Article No.	Model	Price/Unit
MR04022	Rubber steering wheels for foldable and non-foldable Big Boxes	7,50 €
MR04065	Rubber steering wheels with brakes for foldable and non-foldable Big Boxes	8,75 €

You find more wheel types on our online shop

# COLLAPSIBLE BIG BOXES PERFORATED

## TRANSPORTATION ERGONOMICS

Longer shelf life for perishable goods due to effective ventilation slots

- ventilation slots in base and sides
- capacity optimizing sides
- base and side construction protects contents
- hygienic construction



### SPECIAL COLOURS

Available in all RAL-colours for an additional surcharge (P. 100)



### AVAILABLE UP FROM 1 PIECE!

No minimum purchase order. Excl. VAT; The per-pallet price is only applicable for complete pallets.

Order now & save money!  
e.g.:  
Collapsible bulk container  
with ventilation slots  
120 x 80 x 100 cm  
KLO 1208

Our best price  
from €

**119,<sup>95</sup>**

### FOLDABLE BULK CONTAINER PERFORATED

Dimensions L x W x H (cm)	Article No.	Colour	Model	Price for single unit	Units per storing position	Price/Unit per storing position
120 x 80 x 100	KLO 1208	silver grey	with 4 feet	143,94 €	5	119,95 €
120 x 80 x 100	KLO 1208K	silver grey	with 3 skids	155,94 €	5	129,95 €
120 x 100 x 100	KLO 1210	silver grey	with 4 feet	167,94 €	5	139,95 €
120 x 100 x 100	KLO 1210K	silver grey	with 3 skids	179,94 €	5	149,95 €
120 x 100 x 79	KSO 1210	silver grey	with 4 feet	155,94 €	5	129,95 €
120 x 100 x 79	KSO 1210K	silver grey	with 3 skids	167,94 €	5	139,95 €



Lids for Big Boxes  
Extremely sturdy and stackable!

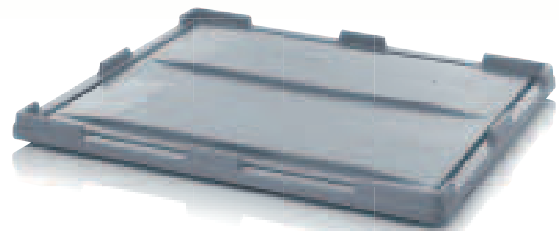

### LIDS FOR BIG BOXES

Dimensions L x W (cm)	Article No.	Colour	Price for single unit	Units per storing position	Price/Unit per storing position
120 x 80	DE 1208	silver grey	38,74 €	50	32,28 €
120 x 100	DE 1210	silver grey	40,30 €	50	33,58 €

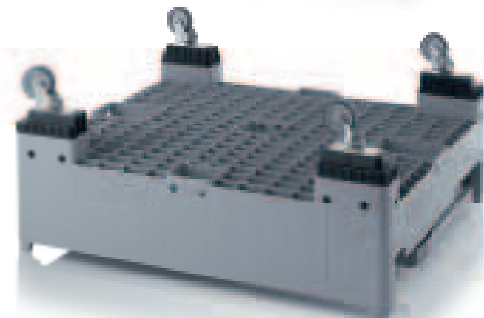
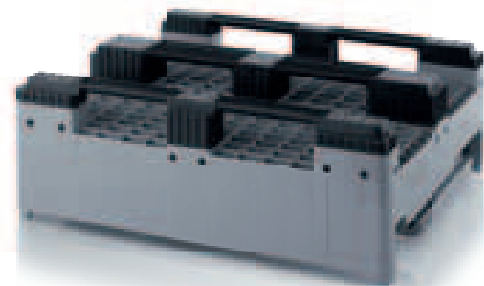
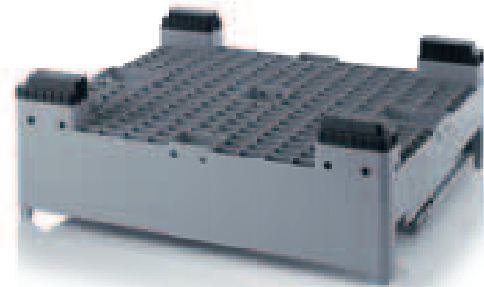
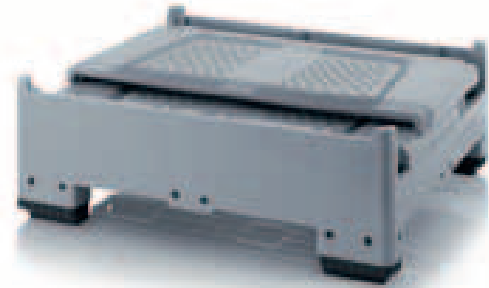

## SINGLE WHEEL FOR SELF-ASSEMBLY

Article No.	Model	Price/Unit
MR04022	Rubber steering wheels for foldable and non-foldable Big Boxes	7,50 €
MR04065	Rubber steering wheels with brakes for foldable and non-foldable Big Boxes	8,75 €

You find more wheel types on our online shop

# COLLAPSIBLE BULK CONTAINERS

## PROVE REAL GREATNESS

Our GLT production line of collapsible bulk containers are the food-safe hygienic and thermo containers in AUER Packaging's product range. These containers feature smooth outside and inside walls and can therefore be cleaned easily and thoroughly. Twin wall construction of the walls ensures maximum protection for product's. The lids of the GLTs can be locked and sealed making unauthorized opening impossible.

- ideal for transporting and storing food
- easily cleaned with no dirt traps
- isolated against heat and cold by double-walls
- space-saving when empty
- also stackable with lids
- security sealable



Order now & save money!  
e.g.:  
Collapsible bulk containers  
GLT 86/83K  
Price/Unit per storing position

Our best price  
from €

**111,<sup>10</sup>**



## COLLAPSIBLE BULK CONTAINERS

Dimensions L x W x H (cm)	Article No.	Colour	Model	Price for single unit	Units per storing position	Price/Unit per storing position
80 x 60 x 81	GLT 86/83K	silver grey	2 skids	133,32 €	12	111,10 €
120 x 80 x 88	GLT 1208/91	silver grey	4 feet	218,38 €	5	181,98 €
120 x 80 x 88	GLT 1208/91K	silver grey	3 skids	255,12 €	5	212,60 €
120 x 100 x 122	GLT 1210/125	silver grey	4 feet	333,76 €	5	278,13 €
120 x 100 x 122	GLT 1210/125K	silver grey	3 skids	370,49 €	5	308,74 €

## LID FOR COLLAPSIBLE BULK CONTAINER

Dimensions L x W (cm)	Article No.	Colour	Model	Price for single unit	Units per storing position	Price/Unit per storing position
80 x 60	DE 86 IBC	silver grey	with 4 sash locks	18,76 €	50	15,63 €
120 x 80	DE 1208 IBC	silver grey	with 4 sash locks	44,47 €	25	37,28 €
120 x 100	DE 1210 IBC	silver grey	with 4 sash locks	46,30 €	25	38,58 €



**AVAILABLE UP FROM 1 PIECE!**  
No minimum purchase order. Excl. VAT; The per-pallet price is only applicable for complete pallets.

Collapsible  
Big Boxes



### WHEELS FOR SELF INSTALLATION

Article No.	Model		Price/Unit
[Article No. of the GLT] R	4-piece set	Additional Price	+30,00 €
[Article No. of the GLT] RB	wheels with breaks 4-piece set	Additional Price	+35,00 €

You find more wheel types on our online shop

# CLOSING SYSTEM

## FOR COLLAPSIBLE BIG BOXES

Secure valuable or sensitive goods reliably from unauthorized persons! With our locking-systems your foldable bigboxes are on the safe side, already when being delivered, as the locking-system will directly being assembled in our factory.

Please note:

- all solutions, except of the pad lock with eyebolt SC, can only be mounted on side-walls without flaps.

- Hinges are only mouted on the long sides of the boxes

- if a container is equipped with hinges, the padlocks should only be fixed opposite the hinges.

**Toggle-type fastener SV**  
to secure hold the lid and close the container  
(1 unit is required per box)  
Images with item 41132 2

### Locking hinge SA

- middle adjustment of 95°
- very stable  
(per container are required 2 units)



### CLOSING SYSTEM SA/SV FOR BIG BOXES

Article No.	Model	Price/Unit
SV	Toggle-type fastener*	25,00 €
SA	Locking hinge*	25,00 €
41132 2	no fixed padlock*	3,91 €
[Article No. of container] SASV	2 fixing hinges, 1 fastener	+75,00 €

\*) available with appropriate fasteners for single units



**Locking hinge SA**

- middle adjustment of 95°
  - very stable
- (per container are required 2 units)

**Padlock with eyebolt SC**

simultaneous locking lock

Scope of supply SC for foldable bigboxes

- 1 padlock
  - 1 eyebolt
  - 1 locking nut
  - 1 standard nut
- (per container are required 4 units)

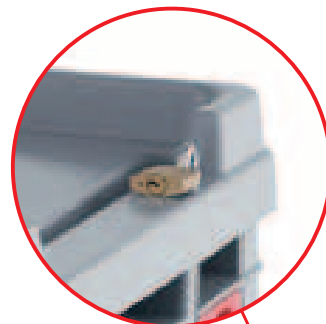
**CLOSING SYSTEM SC/SA FOR BIG BOXES**

Article No.	Model	Price/Unit
SC	Padlock with eyebolt*	10,00 €
SA	Locking hinge*	25,00 €
[Article No. of container] SASC	2 fixing hinges, 2 padlocks with eyebolts	+70,00 €
[Article No. of container] SC	4 padlocks with eyebolts	+40,00 €

\*) available with appropriate fasteners for single units





# BAG IN BOX SYSTEM / IBC

## FOR LIQUIDS

By using a single use liner bag, the AUER IBC-System offers a very hygienic and safe solution, including the option of aseptic liner.

Advantages compared to traditional non returnable or rigid systems:

- Significant reduction in transport costs
- Reusable container (only the liner bag is disposable)
- More hygienic due to smooth surfaces and rounded off edges
- Double skin design of IBC walls gives excellent product protection against fork impact. RFID technology available for track and trace of your asset
- User friendly filling and discharge methods. Safe and easy to transport
- Optimal space utilization – stackable and collapsible
- Single use liner eliminates expensive cleaning costs and associated operational time
- Extended shelf life for product filled aseptically, even if part discharged
- No pressure balance necessary
- One man operation
- High stack load rating
- inclusive sealable lid

- Reinforced side walls for strength and stability

- Three runners for use with all materials handling equipment



### IBC CONTAINER 250 L, 500 L, 1000 L

Dimensions L x W x H (cm)	Article No.	Colour	Model	Price for single unit	Units per storing position	Price/Unit per storing position
80 x 60 x 83	IBC 250	silver grey		178,33 €	12	148,61 €
120 x 80 x 91	IBC 500	silver grey		321,37 €	5	267,81 €
120 x 100 x 125	IBC 1000	silver grey		445,42 €	5	371,19 €
120 x 100 x 125	IBC 1000 EK	silver grey	cut-out handles with flaps	469,42 €	5	391,19 €
Seal	PB	black		0,20 €		

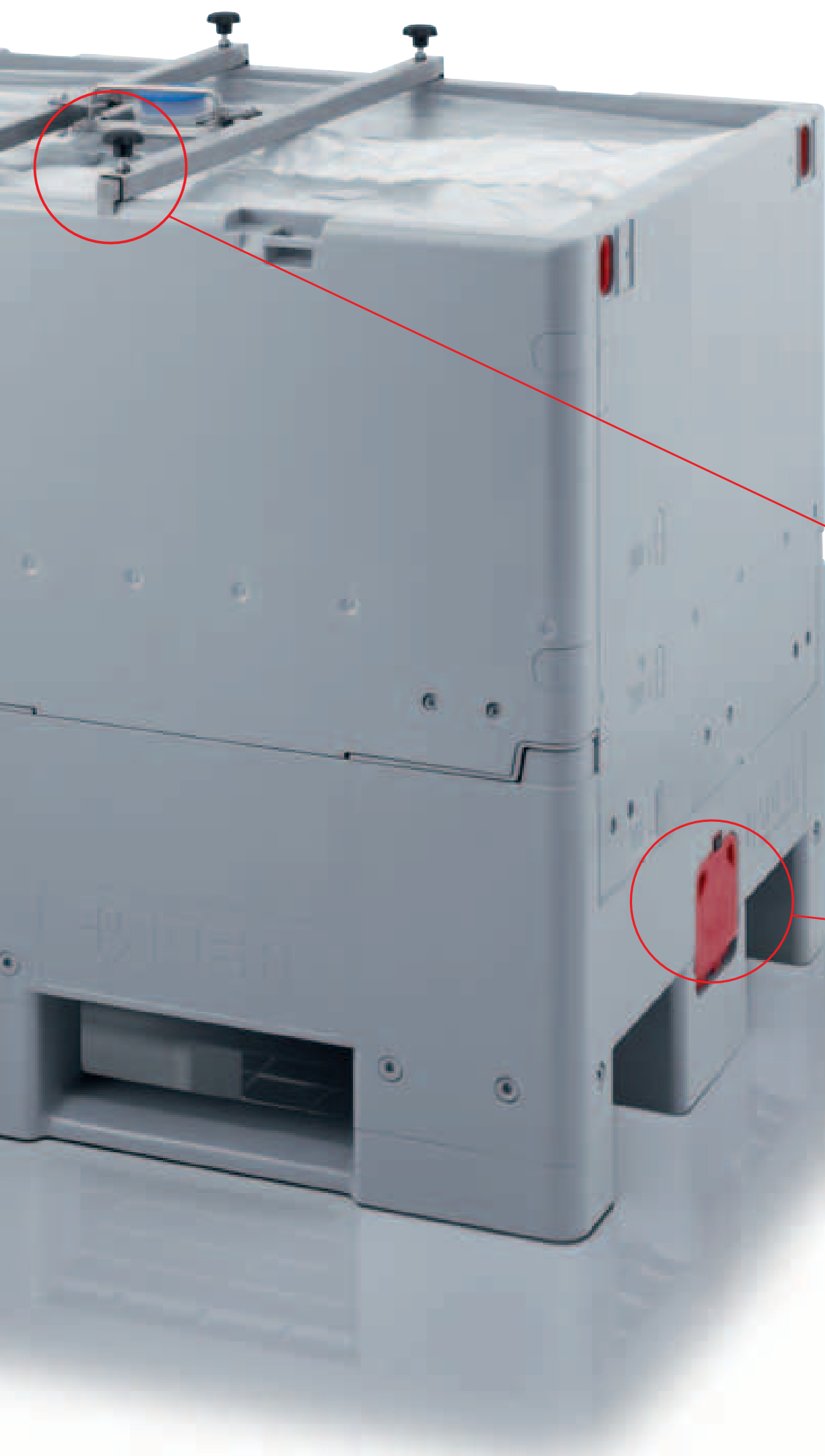

■ Filling bridge out of high quality stainless steel for an easy and clean filling of the liner bag

■ Tamper evident cover flap indicates any unauthorised opening during transport

## HYGIENIC, SAFE AND ECONOMICAL

The replaceable liner bag provides maximum safety and hygiene.

- With our disposable liner bag no expensive chemical cleaning products needed
- No additional personnel costs required for cleaning the liner bag
- Materials approved for food contact
- Form fit welded liner bag
- Material 70 my Coex LDPE / Metalocene / LDPE
- 2" inlet with closure

On request, the liner bag is available in aseptic form

- Gamma-irradiated
- Separately wrapped in a sterile bag
- Outlet DN 50 with hemisphere ball valve or
- outlet 2" S60 (V2) respectively 6" (V6) external thread with butterfly valve



## LINER BAGS STANDARD, FOOD SAFE

Volume (Litre)	Article No.	Model	Units per carton	Price/Unit in carton	Units per pallet	Price/Unit on pallet
250	INL 250A2E2	Outlet 2" with closure, Inlet 2" with closure	25	12,99 €	300	9,99 €
250	INL 250V2E2	Outlet 2" with valve, Inlet 2" with closure	25	16,18 €	300	12,44 €
500	INL 500A2E2	Outlet 2" with closure, Inlet 2" with closure	15	14,83 €	180	11,41 €
500	INL 500V2E2	Outlet 2" with valve, Inlet 2" with closure	15	18,01 €	180	13,86 €
500	INL 500A2E6	Outlet 2" with closure, Inlet 6" with closure	15	26,30 €	180	20,23 €
500	INL 500V2E6	Outlet 2" with valve, Inlet 6" with closure	15	29,48 €	180	22,68 €
1000	INL 1000A2E2	Outlet 2" with closure, Inlet 2" with closure	12	17,01 €	144	13,08 €
1000	INL 1000V2E2	Outlet 2" with valve, Inlet 2" with closure	12	20,19 €	144	15,53 €
1000	INL 1000A2E6	Outlet 2" with closure, Inlet 6" with closure	12	28,29 €	144	21,76 €
1000	INL 1000V2E6	Outlet 2" with valve, Inlet 6" with closure	12	31,47 €	144	24,21 €
1000	INL 1000DN50E0	Outlet DN50 with valve, no Inlet	12	30,65 €	144	23,58 €
1000	INL 1000V6E6	Outlet 6" with valve, Inlet 6" with closure	12	71,51 €	72	55,01 €

Available also with 3" inlet (prices on request)

## ASEPTIC LINER GAMMA IRRADIATED, SEPERATELY PACKED IN ASEPTIC BAGS

STERILE R



Volume (Litre)	Article No.	Model	Units per carton	Price/Unit in carton	Units per pallet	Price/Unit on pallet
250	S-INL 250A2E2	Outlet 2" with closure, Inlet 2" with closure	25	18,91 €	300	14,54 €
250	S-INL 250V2E2	Outlet 2" with valve, Inlet 2" with closure	25	22,09 €	300	16,99 €
500	S-INL 500A2E2	Outlet 2" with closure, Inlet 2" with closure	15	24,57 €	180	18,90 €
500	S-INL 500V2E2	Outlet 2" with valve, Inlet 2" with closure	15	27,75 €	180	21,35 €
500	S-INL 500A2E6	Outlet 2" with closure, Inlet 6" with closure	15	35,31 €	180	27,16 €
500	S-INL 500V2E6	Outlet 2" with valve, Inlet 6" with closure	15	38,49 €	180	29,61 €
1000	S-INL 1000A2E2	Outlet 2" with closure, Inlet 2" with closure	12	28,38 €	144	21,83 €
1000	S-INL 1000V2E2	Outlet 2" with valve, Inlet 2" with closure	12	31,57 €	144	24,28 €
1000	S-INL 1000A2E6	Outlet 2" with closure, Inlet 6" with closure	12	38,77 €	144	29,82 €
1000	S-INL 1000V2E6	Outlet 2" with valve, Inlet 6" with closure	12	41,95 €	144	32,27 €
1000	S-INL 1000DN50E0	Outlet DN50 with valve, no Inlet	12	41,13 €	144	31,64 €
1000	S-INL 1000V6E6	Outlet 6" with valve, Inlet 6" with closure	12	87,18 €	72	67,06 €

Available also with 3" inlet (prices on request)

## ADAPTOR WITH SEAL

Article No.	Article description	Price/unit
A1	Adaptor of 2" S60 external thread to 2" BSP, adaptor with seal	4,95 €
A2	Adaptor of 2" S60 external thread to 2" Male Cam	4,95 €
A3	Adaptor of 2" S60 external thread to 2" Tri-Clamp	4,95 €
A4	Adaptor of 2" S60 external thread to DIN 50 milk tube	4,95 €

Article No.	Article description	Price/unit
A5	Adaptor of 2" internal thread to DIN 50 milk tube	45,60 €
A6	Adaptor of 2" to 2" internal thread	50,16 €
V50	Butterfly valve of 2" internal thread to 2" internal thread	72,96 €

## ADAPTOR WITH SEAL

Outlet of 2" S60 external thread with butterfly valve (...V)

Outlet of 2" internal thread with closure (...A)

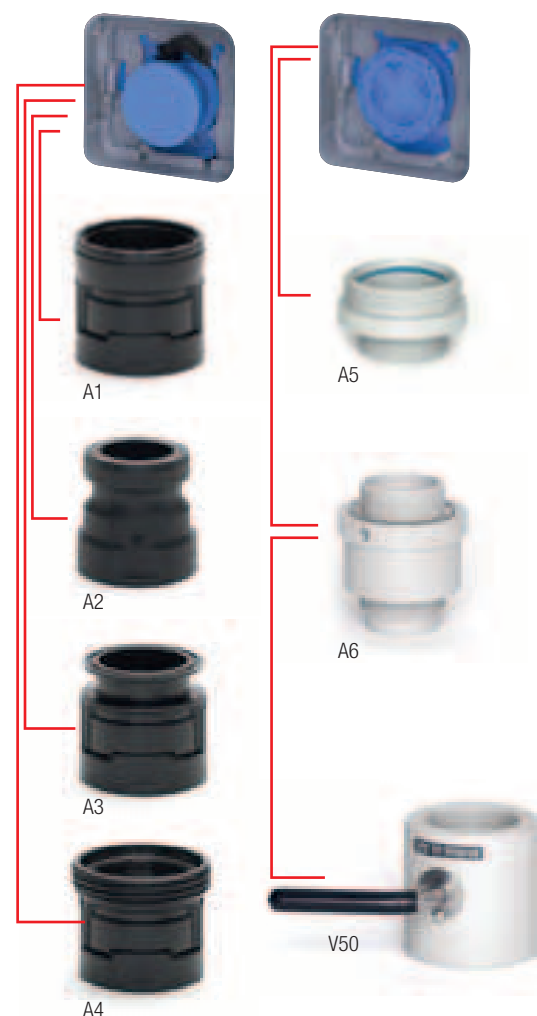

## FEATURES AND BENEFITS

- Stackable – saving valuable racking space
- Reusable – saving costs vs. single use alternatives
- Foldable – saving space in storage and on return transport
- Hygienic – easy to clean smooth surfaces
- Economical – transport amortisation favourable vs. rigid alternatives
- Easy to use – operational savings and higher yield potential

All IBC containers are delivered with lid and outlet. Liner bags have to be ordered separately.

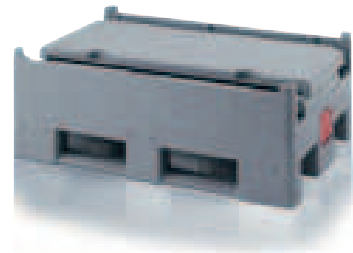

## IBC CONTAINER 250L, 500L, 1000L

Article No.	IBC 250	IBC 500	IBC 1000	IBC 1000 EK
Model	---	---	---	cut-out handles with flaps
Availability	up from 1 unit	up from 1 unit	up from 1 unit	up from 1 unit
Weight of the container	ca. 30 kg	67 kg	102 kg	102 kg
Volume	250 liters	500 liters	1000 liters	1000 liters

Load-bearing capacity				
Load capacity	325 kg	650 kg	1300 kg	1300 kg
Stackable, statically	1+5	1+5	1+5	1+5
Stackable, dynamically	2	2	2	2
Material				
Material ABS	colour: silver grey	colour: silver grey	colour: silver grey	colour: silver grey

Dimensions					
Outer dimensions	length	80 cm	120 cm	120 cm	120 cm
	width	60 cm	80 cm	100 cm	100 cm
	height	83 cm	91 cm	125 cm	125 cm
Inside dimensions	length	74 cm	111 cm	111 cm	111 cm
	width	54 cm	71 cm	91 cm	91 cm
	height	64 cm	69 cm	103 cm	103 cm
Folded	length	80 cm	120 cm	120 cm	120 cm
	width	60 cm	80 cm	100 cm	100 cm
	height	36 cm	43 cm	43 cm	43 cm

Bag in Box System / IBC

## IBC FILLING BRIDGE

Article No.	Article description	Price/unit
BB IBC	Filling bridge - stainless steel	300,00 €





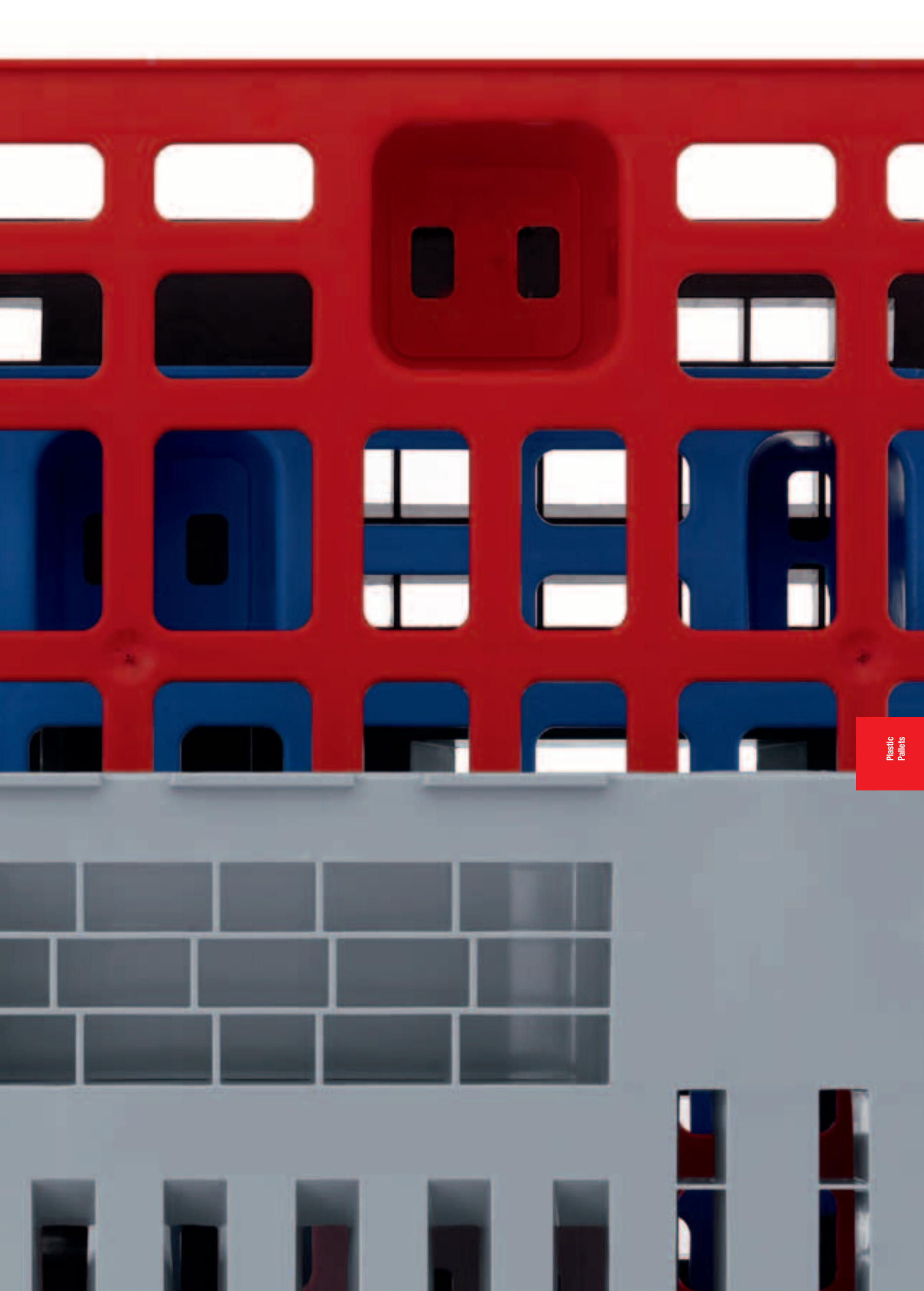

## ROBUST LIGHTWEIGHTS

Our lightweight plastic pallets can be nested one into the other to save space. They have a high load-bearing capacity despite their low tare.



Suitable for worldwide export.

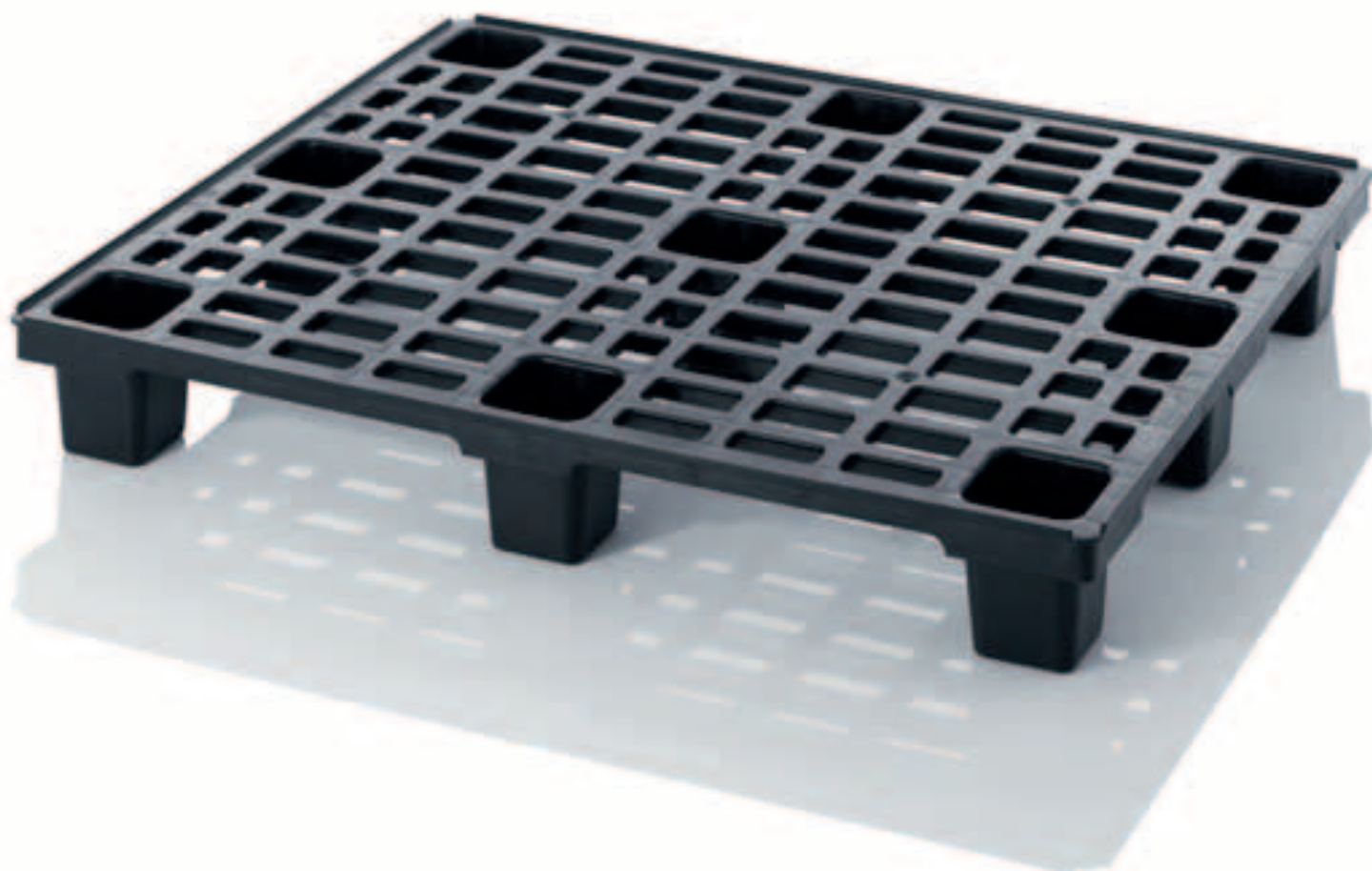

Order now & save money!  
e.g.:  
Lightweight Pallet  
120 x 80  
with 9 feet  
LP 1208

Our best price  
from €

**7,99**

**AVAILABLE UP FROM 1 PIECE!**

No minimum purchase order. Excl. VAT; The per-pallet price is only applicable for complete pallets.

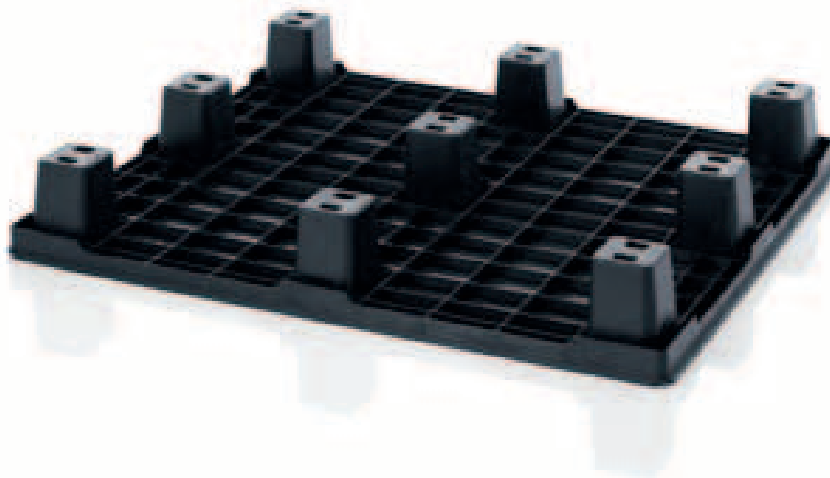

### LIGHTWEIGHT PALLETS WITH FEET, BLACK

Dimensions L x W (cm)	Article No.	Model	Units per carton	Price for single unit	Units per storing position	Price/Unit per storing position
80 x 60	LP 86	with 6 feet	10	6,35 €	100	5,29 €
120 x 80	LP 1208	with 9 feet	–	9,59 €	50	7,99 €
120 x 100	LP 1210	with 9 feet	–	10,79 €	50	8,99 €



Due to the skids, our lightweight pallets become even more stable as well as the torsional stiffness increases. Especially high weights, this pallets can be perfectly moved with fork lifters.



Order now & save money!  
e.g.:  
Lightweight Pallet  
120 x 80  
with 3 skids  
LP 1208K

Our best price  
from €  
**12,34**

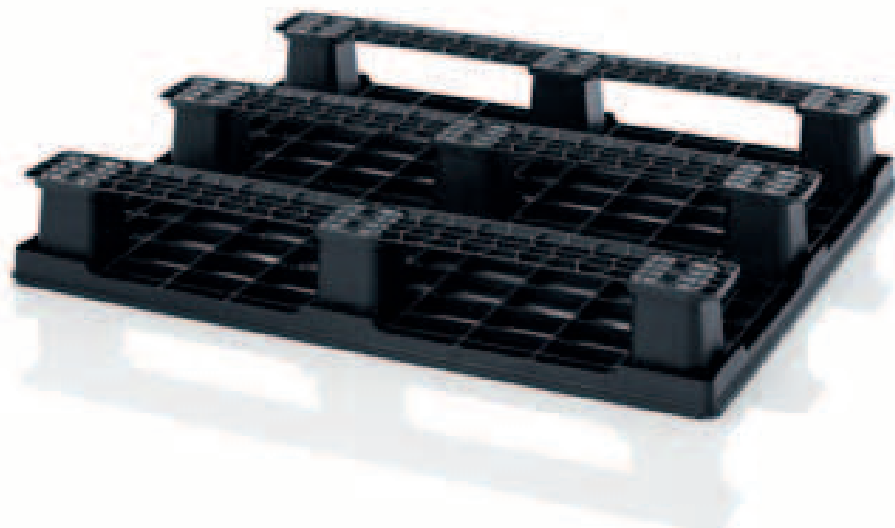

### LIGHTWEIGHT PALLETS WITH SKIDS, BLACK

Dimensions L x W (cm)	Article No.	Model	Units per carton	Price for single unit	Units per storing position	Price/Unit per storing position
120 x 80	LP 1208K	with 3 skids	–	14,81 €	23	12,34 €
120 x 100	LP 1210K	with 3 skids	–	16,01 €	23	13,34 €

# MEDIUM PALLETS

## STRONG ALL-ROUNDERS

Our medium pallets have stability characteristics between the lightweight and hygienic / high-rack pallets. They are also made of scratch-resistant, high quality plastic.



Suitable for worldwide export.

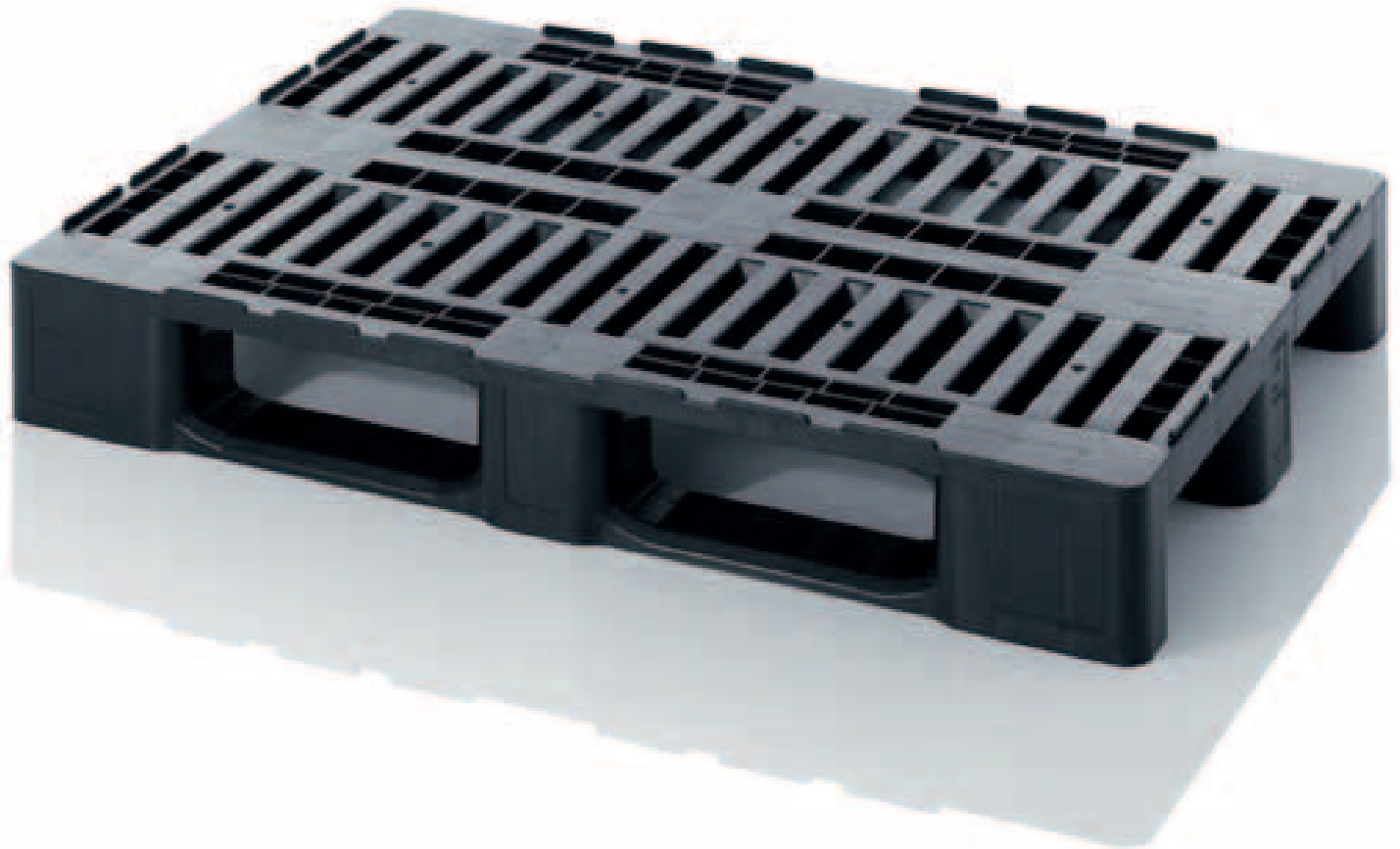

Order now & save money!  
e.g.:  
Medium Pallet 120 x 80  
with skids  
MP 1208

Our best price  
from €

**26,<sup>23</sup>**

**AVAILABLE UP FROM 1 PIECE!**  
No minimum purchase order. Excl. VAT; The per-pallet price is only applicable for complete pallets.

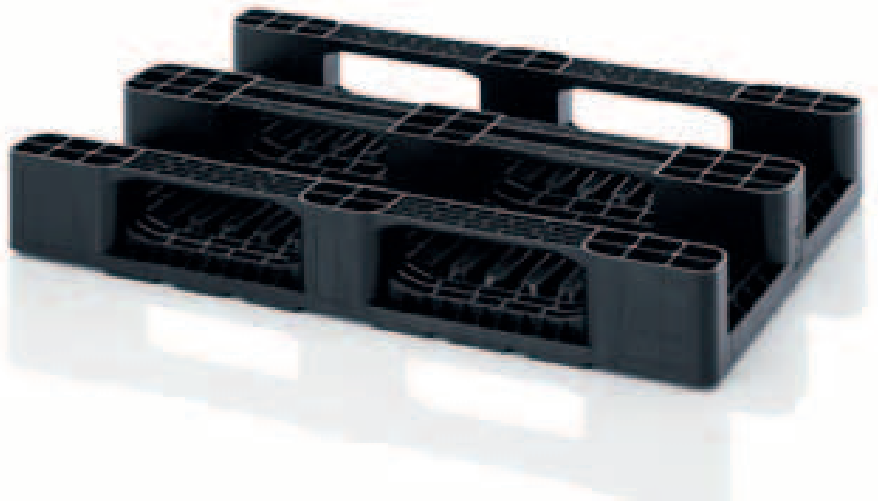

### MEDIUM PALLETS WITH SKIDS, BLACK

Dimensions L x W (cm)	Article No.	Colour	Model	Price for single unit	Units per sto- ring position	Price/Unit per storing position
120 x 80	MP 1208	black	with 3 skids	31,48 €	14	26,23 €
120 x 100	MP 1210	black	with 3 skids	28,85 €	14	24,04 €
120 x 100	MP 12105	black	with 5 skids	33,61 €	14	28,01 €

## HEAVY-WEIGHT CHAMPIONS



The perfect solution for high weights in high-racks. HD-pallets with steel tube reinforcements!

■ Superimposed load of up to 1500 kg

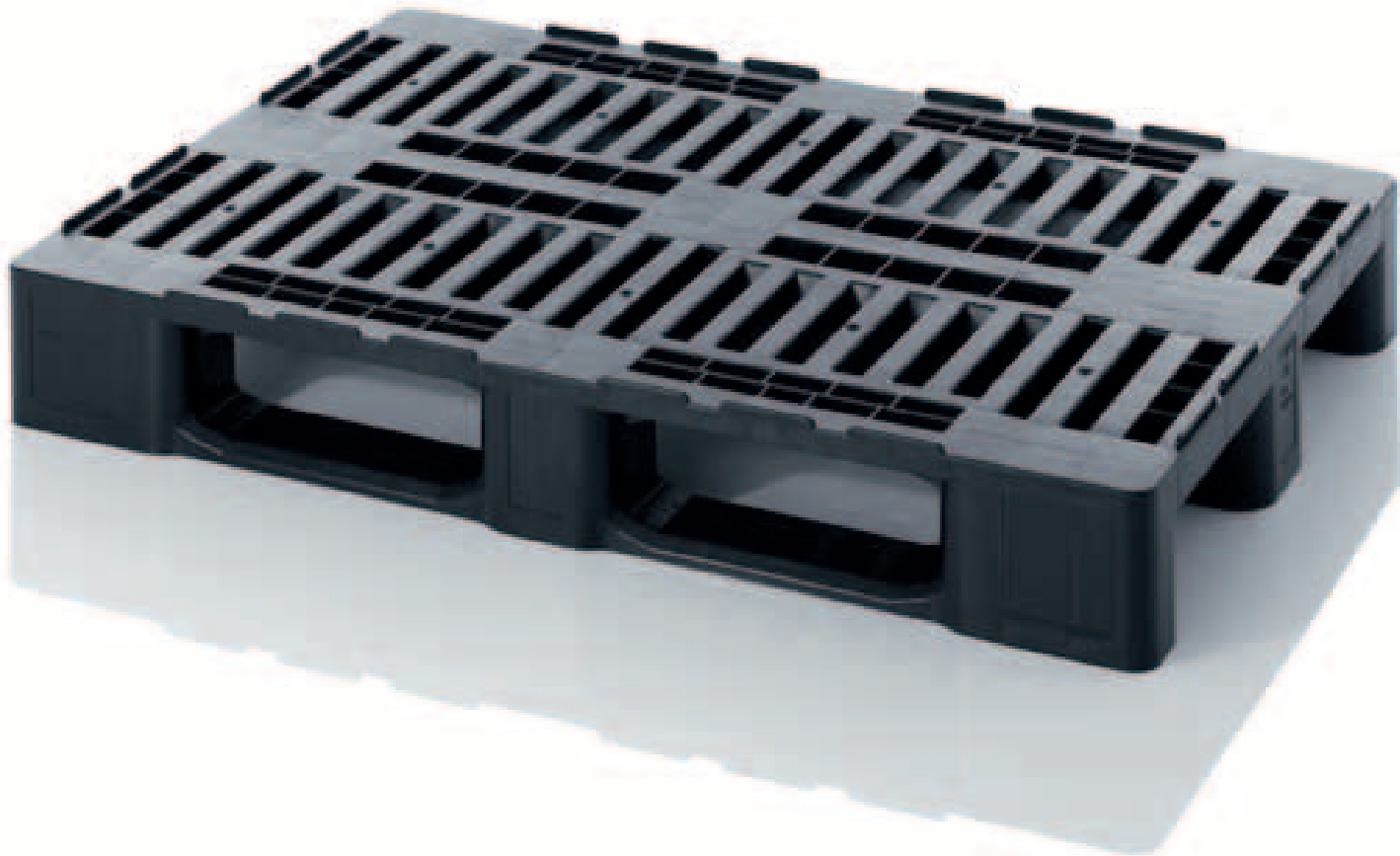

Order now & save money!  
e.g.:  
HD Palette 120 x 80  
with skids  
MPHD 1208

Our best price  
from €

**36,<sup>23</sup>**

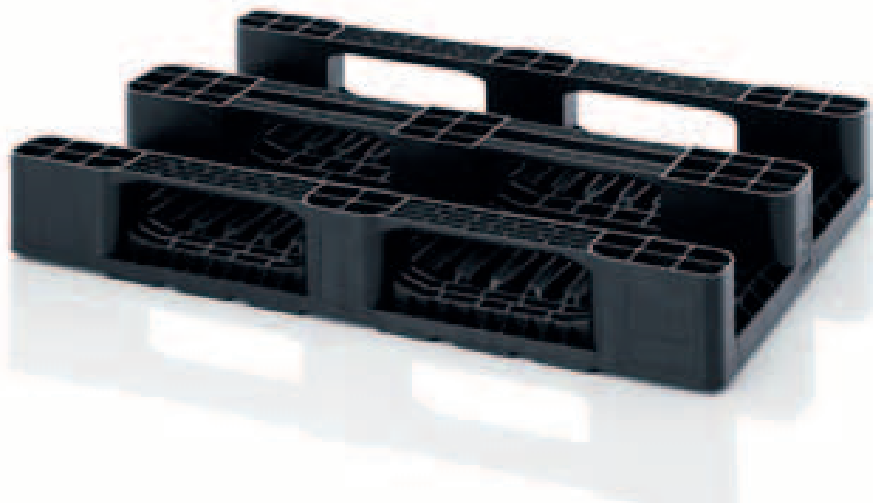

Plastic  
Pallets

### HD PALETTS WITH SKIDS, BLACK

Dimensions L x W (cm)	Article No.	Colour	Model	Price for single unit	Units per storing position	Price/Unit per storing position
120 x 80	MPHD 1208	black	with 3 skids	43,48 €	14	36,23 €
120 x 100	MPHD 1210	black	with 3 skids	40,85 €	14	34,04 €
120 x 100	MPHD 12105	black	with 5 skids	45,61 €	14	38,01 €

# HYGENIC PALLETS WITH CLOSED SURFACE

## TRY IT SMOOTH NOW!

In autumn 2012, a completely new generation of hygienic pallets will be available. The surface of these pallets will be closed, whereby it will get even more easy to clean them. The new pallet generation will replace our MPHD-pallets. As a cheap alternative we will also offer this closed version made of reclaimed material, while our hygienic pallets will be made of 100% PE-HD new material.

■ Loading capacity with steel tube reinforcements:  
dynamic load: 2.5 t  
static load: 4.5 t  
high rack: 1.5 t

■ Loading capacity without steel tube reinforcements:  
dynamic load: 1.5 t  
static load: 3.5 t  
high rack: 300 kg

Available with or without outside adjustments

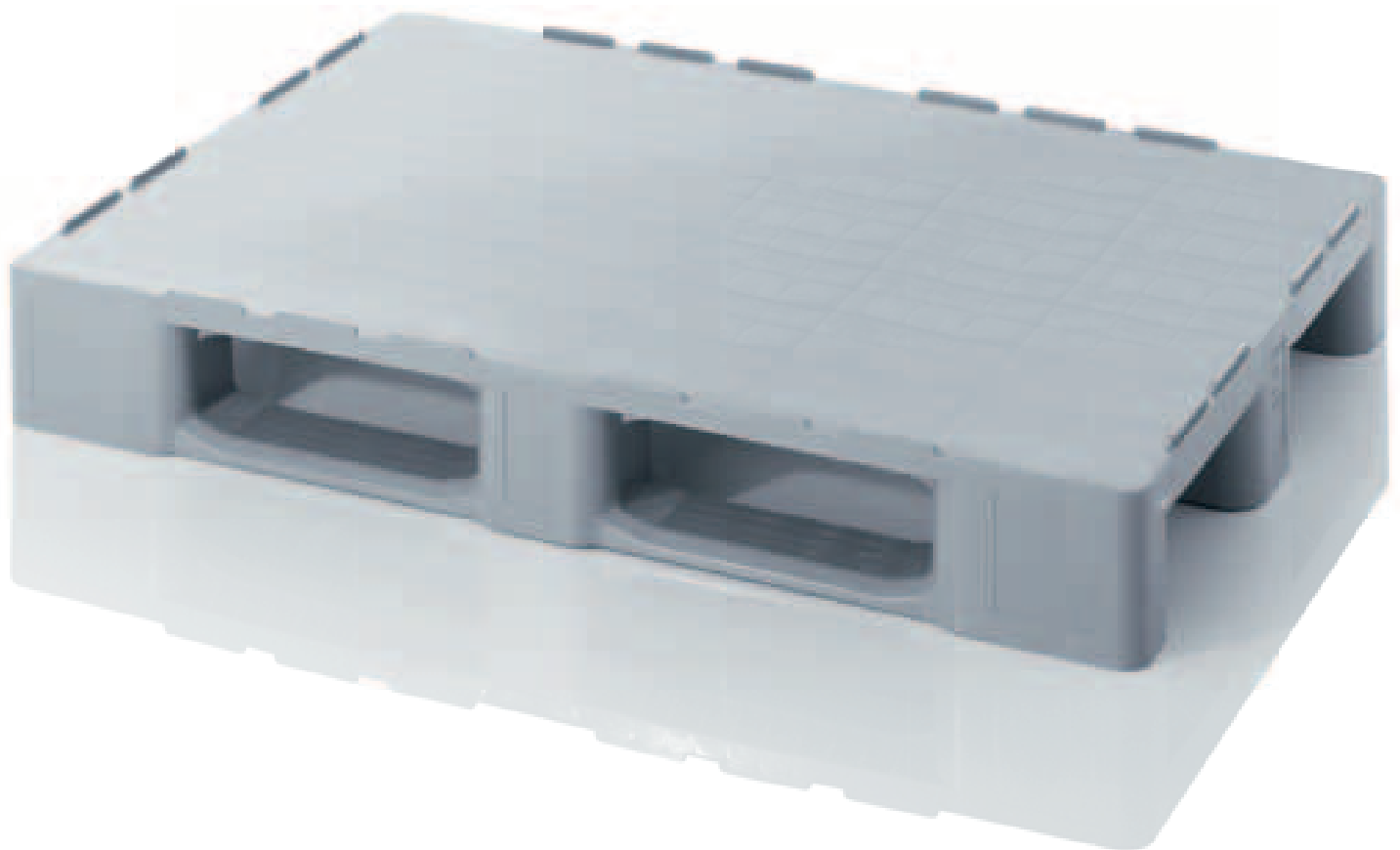

## HYGENIC PALLETS WITH CLOSED SURFACE

Dimensions L x W (cm)	Article No.	Colour	Model	Material
120 x 80	H 1208	silver grey	without steel tube, with 3 skids	HDPE - new material
120 x 80	HD 1208	silver grey	with 2 steel tubes, with 3 skids	HDPE - new material
120 x 100	H 1210	silver grey	without steel tube, with 3 skids	HDPE - new material
120 x 100	HD 1210	silver grey	with 2 steel tubes, with 3 skids	HDPE - new material
120 x 100	H 12105	silver grey	without steel tube, with 5 skids	HDPE - new material
120 x 100	HD 12105	silver grey	with 2 steel tubes, with 5 skids	HDPE - new material

As a cheap alternative we will also offer this closed version made of reclaimed material, while our hygienic pallets will be made of 100% PE-HD new material.

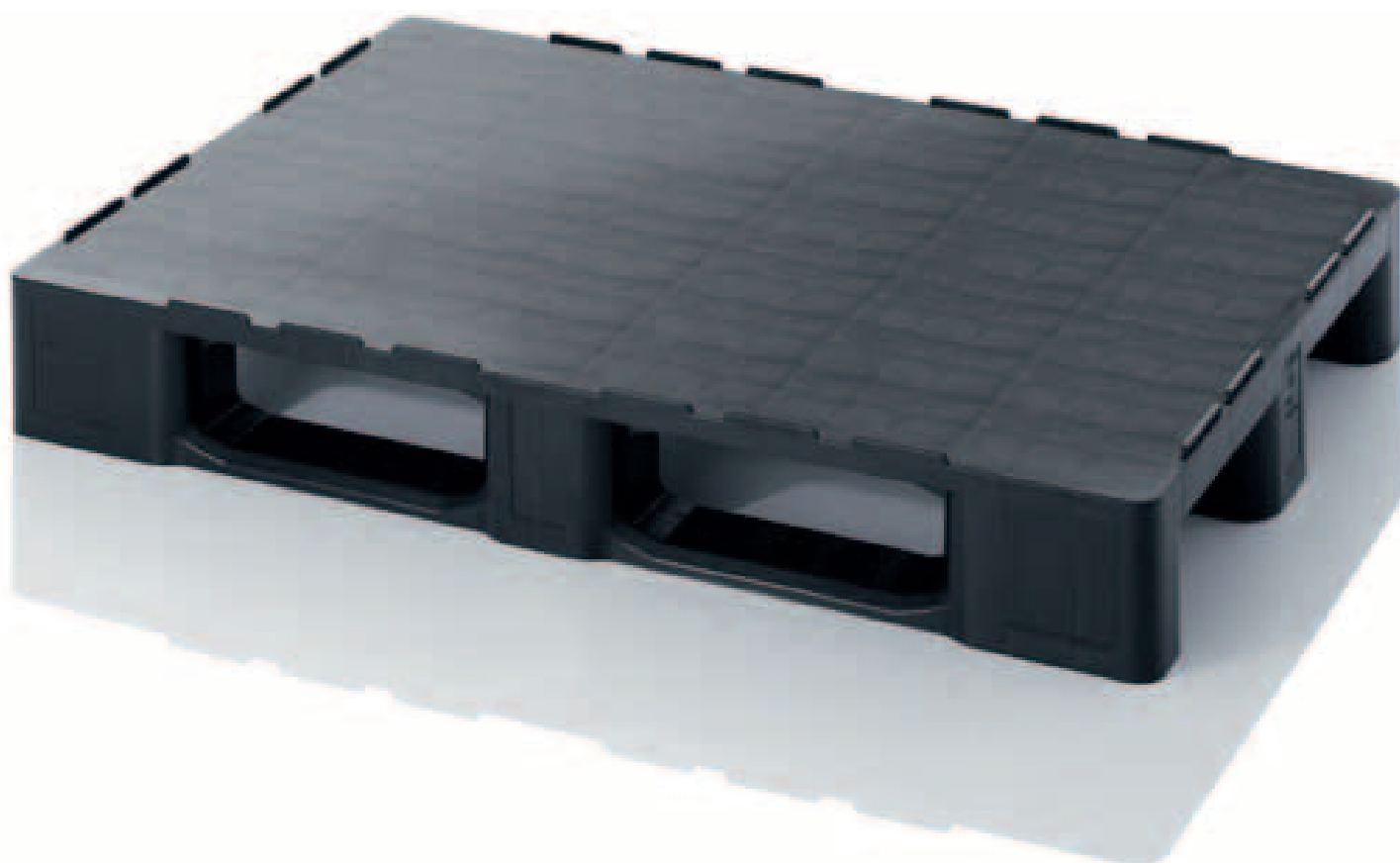

### HYGIENIC PALLETS WITH CLOSED SURFACE MADE OF RECLAIMED MATERIAL

Dimensions L x W (cm)	Article No.	Colour	Model	Material
120 x 80	R 1208	black	without steel tube, with 3 skids	reclaimed material
120 x 80	RD 1208	black	with 2 steel tubes, with 3 skids	reclaimed material
120 x 100	R 1210	black	without steel tube, with 3 skids	reclaimed material
120 x 100	RD 1210	black	with 2 steel tubes, with 3 skids	reclaimed material
120 x 100	R 12105	black	without steel tube, with 5 skids	reclaimed material
120 x 100	RD 12105	black	with 2 steel tubes, with 5 skids	reclaimed material

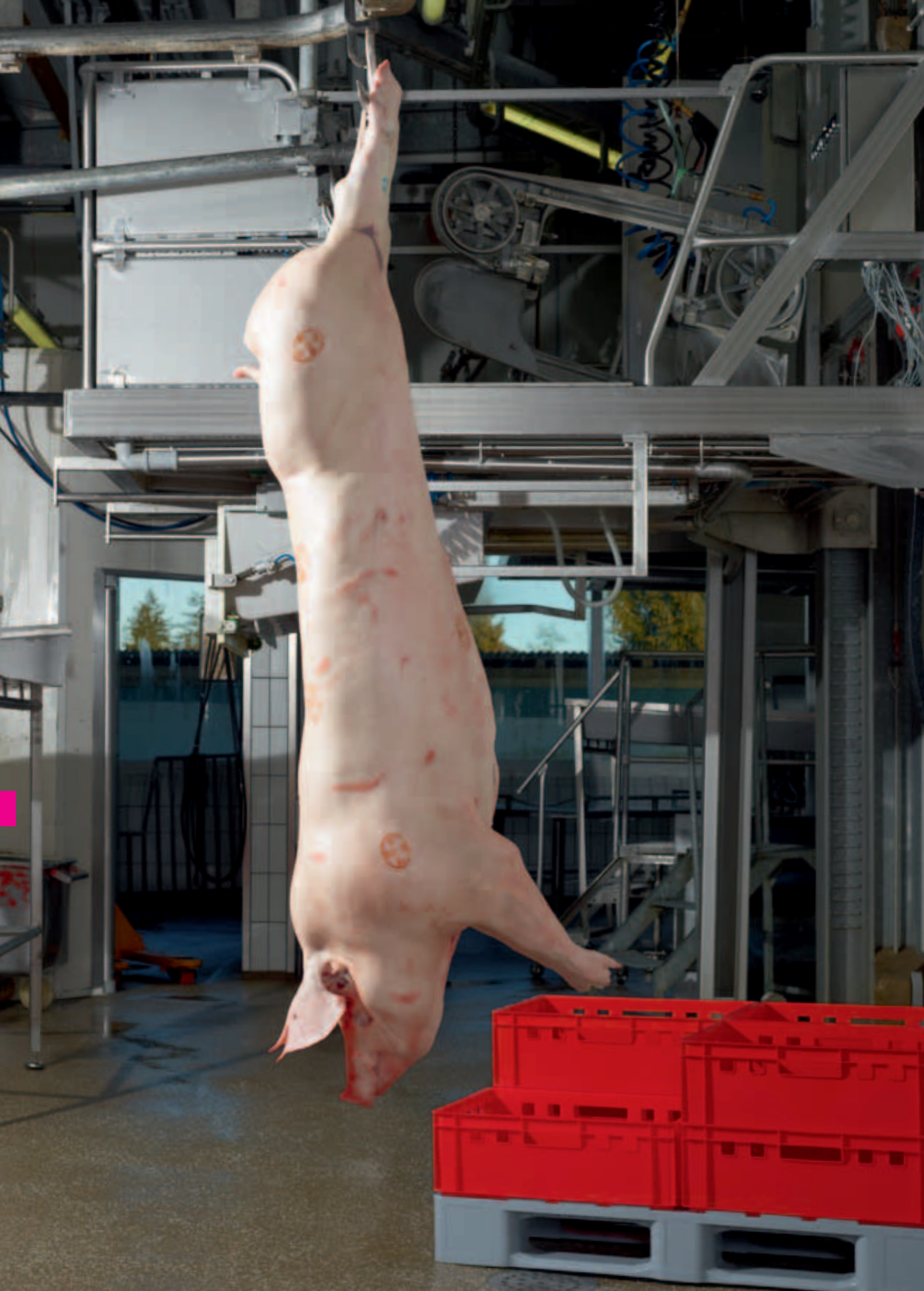



## CLEAN MAXIMUM PERFORMANCE



These hygienic pallets are made of new material approved for use with foodstuffs.

These monoblock pallets, manufactured in one piece, are heat- and cold-resistant, and easy to clean.

Suitable for worldwide export.



Order now & save money!  
e.g.:  
Hygienic Pallet 120 x 80  
welded, with skids  
H1

Our best price  
from €

**42,60**

**AVAILABLE UP FROM 1 PIECE!**  
No minimum purchase order. Excl. VAT; The per-pallet price is only applicable for complete pallets.



### HYGIENIC PALLETS

EXTREMELY STURDY – ALSO SUITABLE FOR HIGH RACKS

Dimensions L x W (cm)	Article No.	Colour	Model	Price for single unit	Units per storing position	Price/Unit per storing position
120 x 80	H1	silver grey	3 skids welded	51,12 €	14	42,60 €
120 x 80	H1-RG	silver grey	3 skids not welded	44,04 €	14	36,70 €
120 x 100	H3	silver grey	3 skids not welded	38,70 €	14	32,25 €
120 x 100	H3+5	silver grey	5 skids not welded	41,75 €	14	34,79 €

## MEAT CRATE

### HYGIENIC STORAGE FOR MEAT

Meat  
industry

A hygienic transport and storage of meat and sausage products: The AUER meat boxes in the E2 format is according to DIN 55423-conform and meet the strict requirements of the EHI.

- Optimize the use of automated logistics (suitable for roller conveyors and roller belt)
- Water is drained from the edge to outside



### MEAT CRATE

Dimensions L x W x H (cm)	Article No.	Colour	Units per carton	Units per pallet	Price/Unit
60 x 40 x 20	E2	red	9	55	on request





# ESD EURO CONTAINERS

## ABSOLUTELY ANTISTATIC



The ESD containers made of conductive plastics were especially designed for transporting sensitive electronic devices. They reliably prevent electrostatic charge and divert already existing charges. Special volume resistivity/surface resistivity:  $10^6 < 10^{10}$  Ohm cm



**AVAILABLE UP FROM 1 PIECE!**  
No minimum purchase order. Excl. VAT; The per-pallet price is only applicable for complete pallets.



Order now & save money!  
e.g.:  
ESD Euro containers  
60 x 40 x 22  
ESD EG 64/22 HG  
Price/Unit on pallet

Our best price  
from €

**10,09**

### LIDS - ELECTRICALLY CONDUCTIVE

Dimensions L x W (cm)	Article No.	Colour	Units per carton	Price/Unit in carton	Units per pallet	Price/Unit on pallet
40 x 30	ESD DE 43	black	100	5,92 €	800	4,93 €
60 x 40	ESD DE 64	black	45	8,38 €	600	6,98 €
80 x 60	ESD DE 86	black	20	19,01 €	300	15,84 €

### ESD EURO CONTAINERS

Dimensions L x W x H (cm)	Article No.	Colour	Units per carton	Price/Unit in carton	Units per pallet	Price/Unit on pallet
40 x 30 x 12	ESD EG 43/12 HG	black	30	5,78 €	190	4,82 €
40 x 30 x 17	ESD EG 43/17 HG	black	24	6,95 €	130	5,79 €
40 x 30 x 22	ESD EG 43/22 HG	black	18	7,90 €	100	6,58 €
40 x 30 x 27	ESD EG 43/27 HG	black	12	8,59 €	80	7,16 €
40 x 30 x 32	ESD EG 43/32 HG	black	6	9,60 €	70	8,00 €
60 x 40 x 7,5	ESD EG 64/75 HG	black	21	7,09 €	140	5,91 €
60 x 40 x 12	ESD EG 64/12 HG	black	15	8,99 €	75	7,49 €
60 x 40 x 17	ESD EG 64/17 HG	black	9	10,30 €	60	8,58 €
60 x 40 x 22	ESD EG 64/22 HG	black	9	12,11 €	45	10,09 €
60 x 40 x 27	ESD EG 64/27 HG	black	9	14,09 €	40	11,74 €
60 x 40 x 32	ESD EG 64/32 HG	black	9	14,74 €	45	12,28 €
60 x 40 x 42	ESD EG 64/42 HG	black	3	17,95 €	30	14,96 €
80 x 60 x 12	ESD EG 86/12 HG	black	4	20,44 €	34	17,03 €
80 x 60 x 22	ESD EG 86/22 HG	black	2	26,50 €	20	22,08 €
80 x 60 x 32	ESD EG 86/32 HG	black	1	33,88 €	12	28,23 €
80 x 60 x 42	ESD EG 86/42 HG	black	1	40,26 €	10	33,55 €

# ESD EURO CONTAINERS WITH LID

## COMPLETELY PROTECTED

The complete range of ESD Euro containers is also available with lids - the lids are made of the same high quality antistatic material

like the containers. Therefore the valuable electronic articles are completely protected.

Special volume resistivity/surface resistivity:  
 $10^6 < 10^{10}$  Ohm cm



**AVAILABLE UP FROM 1 PIECE!**  
 No minimum purchase order. Excl. VAT; The per-pallet price is only applicable for complete pallets.

### ESD EURO CONTAINERS WITH LID + 2 CLOSURES

Dimensions L x W x H (cm)	Article No.	Colour	Units per carton	Price/Unit in carton	Units per pallet	Price/Unit on pallet
40 x 30 x 13,5	ESD ED 43/12 HG	black	24	14,32 €	160	11,93 €
40 x 30 x 18,5	ESD ED 43/17 HG	black	18	14,99 €	120	12,49 €
40 x 30 x 23,5	ESD ED 43/22 HG	black	12	15,59 €	90	12,99 €
40 x 30 x 28,5	ESD ED 43/27 HG	black	12	16,33 €	70	13,61 €
40 x 30 x 33,5	ESD ED 43/32 HG	black	6	17,15 €	60	14,29 €
60 x 40 x 9	ESD ED 64/75 HG	black	21	19,99 €	130	16,66 €
60 x 40 x 13,5	ESD ED 64/12 HG	black	12	20,65 €	75	17,21 €
60 x 40 x 18,5	ESD ED 64/17 HG	black	9	21,29 €	60	17,74 €
60 x 40 x 23,5	ESD ED 64/22 HG	black	6	22,13 €	45	18,44 €
60 x 40 x 28,5	ESD ED 64/27 HG	black	6	22,60 €	35	18,83 €
60 x 40 x 33,5	ESD ED 64/32 HG	black	3	22,97 €	30	19,14 €
60 x 40 x 43,5	ESD ED 64/42 HG	black	3	25,50 €	25	21,25 €
80 x 60 x 14	ESD ED 86/12 HG	black	4	58,62 €	34	48,85 €
80 x 60 x 24	ESD ED 86/22 HG	black	2	63,31 €	18	52,76 €
80 x 60 x 34	ESD ED 86/32 HG	black	1	67,51 €	12	56,26 €
80 x 60 x 44	ESD ED 86/42 HG	black	1	71,41 €	10	59,51 €



Order now & save money!  
 e.g.:  
 ESD Euro containers  
 60 x 40 x 23,5  
 ESD ED 64/22 HG  
 Price/Unit on pallet

Our best price from €

**18,44**

# ESD LIGHTWEIGHT PALLETS

## ABSOLUTELY ANTISTATIC

The ESD pallets out of electrically conductive plastic were especially designed for transporting sensitive electronic devices. They reliably prevent electrostatic charge and divert already existing charges.

Special volume resistivity/surface resistivity:  $10^6 < 10^{10}$  Ohm cm



Order now & save money!  
e.g.:  
ESD lightweight pallet  
with 9 feet  
ESD LP 1208

Our best price  
from €

**23,<sup>06</sup>**

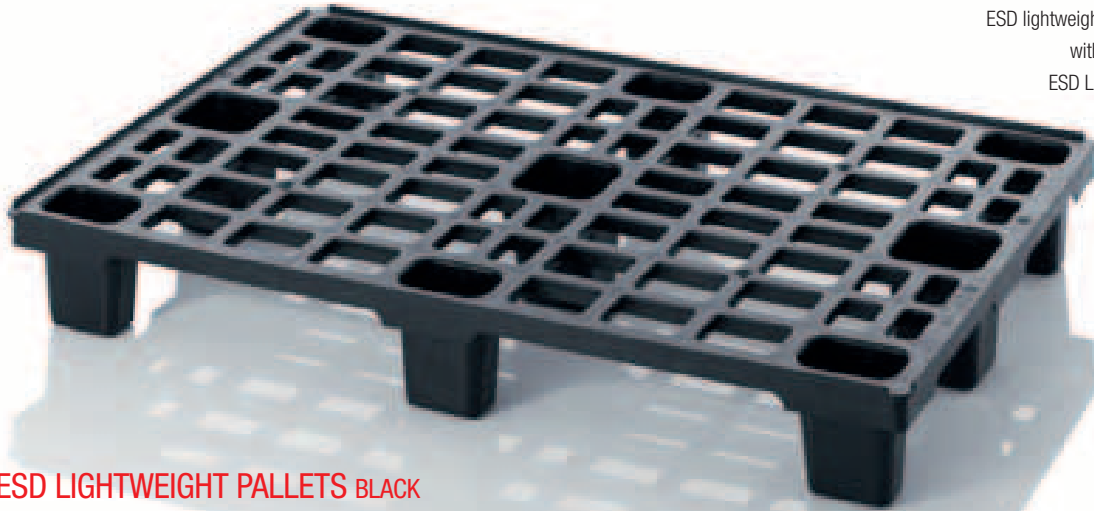

### ESD LIGHTWEIGHT PALLETS BLACK

Dimensions L x W (cm)	Article No.	Model	Colour	Price for single unit	Units per storing position	Price/Unit per storing position
80 x 60	ESD LP 86	with 6 feet	black	22,09 €	100	18,41 €
120 x 80	ESD LP 1208	with 9 feet	black	27,67 €	50	23,06 €
120 x 80	ESD LP 1208K	with 3 skids	black	36,05 €	23	30,04 €
120 x 100	ESD LP 1210	with 9 feet	black	33,24 €	50	27,70 €
120 x 100	ESD LP 1210K	with 3 skids	black	40,55 €	23	33,79 €

# ESD MEDIUM PALLETS

## ABSOLUTELY ANTISTATIC



**AVAILABLE UP FROM 1 PIECE!**  
No minimum purchase order. Excl. VAT; The per-pallet price is only applicable for complete pallets.



Order now & save money!  
e.g.:  
ESD Medium Pallet  
with 3 skids  
ESD MP 1208

Our best price  
from €

**70,<sup>57</sup>**

### ESD MEDIUM PALLETS BLACK

Dimensions L x W (cm)	Article No.	Model	Colour	Price for single unit	Units per storing position	Price/Unit per storing position
120 x 80	ESD MP 1208	with 3 skids	black	84,68 €	14	70,57 €
120 x 100	ESD MP 1210	with 3 skids	black	67,45 €	14	56,21 €
120 x 100	ESD MP 12105	with 5 skids	black	71,34 €	14	59,45 €

## BE STABLE AND MOBILE

Order now & save money!  
e.g.:  
ESD-Trolley  
62 x 42 cm  
ESD RO 64  
Price/Unit on pallet

Our best price  
from €

**34,<sup>43</sup>**

With this trolley you can easily move your ESD-containers from A to B. The size of the trolleys is attuned for a basic measurement of 60 cm x 40 but can also be used for 2 ESD-containers with the dimensions of 40 cm x 30 cm.

- Highly robust, loading capacity of 250 kg
- high quality, smooth-running wheels



### ESD-TROLLEYS

Dimensions L x W (cm)	Article No.	Colour	Units per carton	Price/Unit in carton	Units per pallet	Price/Unit on pallet
62 x 42	ESD RO 64	black	7	41,31 €	80	34,43 €

## „ESD“ PRINT, SHOW YOUR COLORS!



With this print you can signalize explicit that your products are made of special, electrical conductive material. By doing so, you can show your business partners that you handle sensitive goods carefully and confusions with non-electrical conductive containers can be avoided from the start.

ESD-Products

### IMPRINTING „ESD“

Article No.	Article	1 – 50	51 – 100	101 – 200
		per unit	per unit	per unit
DR-ESD B	ESD Euro Container	3,00 €	1,50 €	1,20 €
DR-ESD P	ESD Pallet	10,00 €	5,00 €	3,00 €
DR-ESD RO	ESD Trolley	3,00 €	1,50 €	1,20 €

# ESD-TRANSVERSE DIVIDERS

## FOR ESD-EUROCONTAINERS

The perfect solution if you want to divide your eurocontainers only transverse: A small insert on both long sides enables you to connect the transverse dividers easily, stable and save with the container. We produce your transverse divider inserts according to your requirements! For placing the order, just inform us how many dividers your system should have and how high you want it to be, like shown in the order example.



### ESD DIVIDER CROSS

Article No.	Height	Basic price	extra charge per divider
ESD QT GEF 43 *Q*H	5 - 30 cm	30,00 €	7,50 €
ESD QT GEF 64 *Q*H	5 - 40 cm	30,00 €	9,00 €
ESD QT GEF 86 *Q*H	5 - 40 cm	30,00 €	18,00 €

\*) has to be completed with the quantity and the height required.  
Order Example: **ESD QT GEF 43 4Q20H** is one **ESD-transverse divider insert**, suitable for **40 x 30 containers**, with **5 dividers** and a **height of 20 cm**. Price: 67,50 €

# ESD-LONGITUDINAL DIVIDERS

## FOR ESD-EUROCONTAINERS

The perfect solution if you want to divide your ESD-eurocontainers only longitudinal: A small insert on both sides enables you to connect the transverse dividers save and easily with the containers. We manufacture your transverse dividers according to your requirements! For placing the order just inform us, like shown in the order-example, how many dividers your systems should have and how high you want it to be.



### ESD DIVIDER LENGTH

Article No.	Height	Basic price	extra charge per divider
ESD LT GEF 43 *L*H	5 - 30 cm	30,00 €	9,00 €
ESD LT GEF 64 *L*H	5 - 40 cm	30,00 €	13,50 €
ESD LT GEF 86 *L*H	5 - 40 cm	30,00 €	27,00 €

\*) has to be completed with the quantity and the height required.  
Order Example: **ESD LT GEF 43 5L20H** is one **ESD-longitudinal divider insert**, suitable for our **40 x 30 container**, with **5 dividers** and a **height of 20 cm**. Price: 75 €



No matter in how many compartments you want your ESD-eurocontainer to be divided or how high you want the ESD-insert to be, we can produce tailor-made solutions on request! The functional plug-in system will be pre-milled according to your requirements. When ordering, please inform us not only about the quantity of compartments and the height, but also about the correct quantity of ESD-transverse and longitudinal dividers!



### SPECIAL INSERTS

Article No.	Height	Price divider length	Price divider cross
ESD SGF 43 *L*Q*H	5 - 30 cm	9,00 €	7,50 €
ESD SGF 64 *L*Q*H	5 - 40 cm	13,50 €	9,00 €
ESD SGF 86 *L*Q*H	5 - 40 cm	27,00 €	18,00 €

\*) has to be completed with the quantity and height required.  
 Order example: **ESD SGF 43 5L2Q20H** is one **special insert**, suitable for our **40 x 30 containers**, with **5 longitudinal dividers**, **2 transverse dividers** and a **height of 20 cm**. Price: 60 €

# ESD-INTERMEDIATE PLATES/ CUTS

## SEPARATE IN LAYERS

If you want to establish order inside your ESD-containers, just insert one divider level more. The intermediate plate are tailor-made according to the dimensions of the eurocontainers. On request we can also cut intermediate plates to your requirements.

Order now & save money!  
 e.g.  
 Intermediate plate  
 56,5 x 36,5 cm  
 ESD ZP64  
 Price/Unit on pallet

Our best price  
 from €  
**11,43**



ESD-Products

### INTERMEDIATE PLATE FOR ESD-EUROCONTAINERS

Dimensions L x W (cm)	Article No.	Colour	Units per carton	Price/Unit in carton	Units per pallet	Price/Unit on pallet
36,5 x 26,5	ESD ZP43	black	20	8,65 €	500	7,21 €
56,5 x 36,5	ESD ZP64	black	20	13,70 €	500	11,43 €
75,5 x 55,5	ESD ZP86	black	20	27,66 €	500	23,05 €
pro m <sup>2</sup>	ESD Zm <sup>2</sup>	black		65,00 €		



SWISS

**CHROM**

**Innendis  
Dispersion  
Dispersionsfarbe**

**Giftklassefrei**  
Nur classé de toxicité  
libre de classification  
SAG T/01SP 7/01SP T No. 619 000  
Kein Publikumsprodukt  
Produkt non destiné au public  
Prodotto non destinato al pubblico

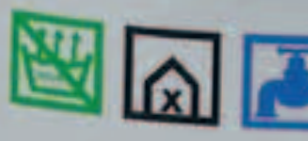

welch  
blan  
blan

SWISS LACK AG, Tischmatten, Postfach, 6015 Reuflingen, CH LU, Telefon 041 2...



 LACK

**MISTAR<sup>®</sup>**

Dispersion  
pour intérieur



Siegfried Keller  
Produktion  
Wallisellen

068 10 30, Fax 0- 268 10 50, info@swisslack.ch, www.swisslack.ch

**KEEPING GOOD THINGS SEALED**

Our plastic buckets are suitable for storing and stocking solid and fluid materials. They are made of polypropylene (PP) and in most cases have a unique closing

system. Approved for the food industry and fitted with anti-lid lifting protection and the rim sealing system, this container is a widely versatile packaging medium.



Order now & save money!  
e.g.  
20 x 11,9 cm, 2,5 l  
ERZ 2,5+D  
Price/Unit on pallet

Our best price  
from €

**0,58**

**PAILS WITH LIDS ABSOLUTELY LEAKPROOF**

Dimensions Ø x H (cm)	Article No.	Contents (Litre)	Colour	Units / carton	Price/Unit in carton	Units/ pallet	Price/Unit pallet
20,0 x 11,9	ERZ 2,5+D	2,5	white	210	0,87 €	1344	0,58 €
20,0 x 13,9	ERZ 3+D	3	white	210	0,92 €	1344	0,61 €
20,0 x 17,7	ERZ 3,8+D	3,8	white	210	0,99 €	1344	0,66 €
22,1 x 15,8	ERZ 4,5+D	4,5	white	140	1,11 €	1012	0,74 €
22,1 x 22,0	ERZ 5,8+D	5,8	white	130	1,17 €	989	0,78 €
28,0 x 27,4	ERZ 10,8+D	10,8	white	65	1,79 €	640	1,19 €
29,1 x 25,6	ERZ 12,5+D	12,5	white	70	1,94 €	560	1,29 €
29,1 x 31,0	ERZ 15+D	15	white	60	2,10 €	560	1,40 €
32,7 x 27,6	ERZ 18+D	18	white	40	2,94 €	315	1,96 €
32,7 x 31,3	ERZ 20+D	20	white	35	3,26 €	279	2,17 €
38,1 x 38,9	ERZ 30+D	30	white	15	5,34 €	224	3,56 €



**SPECIAL COLOURS**  
Available in all RAL-colours for  
an additional surcharge (P. 100)



Order now & save money!  
39,1 x 30,1 x 27,2 cm  
18 l  
EOZ 18+D  
Price/Unit on pallet

Our best price  
from €

**2,07**

### PAILS OVAL WITH LIDS ABSOLUTELY LEAKPROOF

Dimensions Ø x H (cm)	Article No.	Contents (Litre)	Colour	Units / carton	Price/Unit in carton	Units/ pallet	Price/Unit pallet
39,1 x 30,1 x 27,2	EOZ 18+D	18	white	40	3,11 €	340	2,07 €







# RAINWATER SOAKAWAY RIGOLETTO

## OPEN ON ALL SIDES

The AUER soakaway Rigoletto meets all stringent guidelines for an infiltration system free of gravel, which is required by the construction of sealed surfaces.

The main part of this system is a high-performance Rigolen retention unit, made of Polypropylene and a void ratio of 95%. It is equipped with a lateral pipe connec-

tions for KG DN 100, 150 and 200, which can be flown through three-dimensional almost without any resistance and which can be combined in every way you like.

A continuous inspection tunnel allows using an automotive camera car for a pipe of DN 200. The inspection tunnel is equipped with wide-meshed side grids, which

serve for the control of effectively infiltration of outdoor areas as well as for the complete volume of the Rigole with all static relevant supporting elements. The Rigole system is prepared for the professional rainwater infiltration/retention and the retest. It is possible to put it under traffic areas or in huge depths.



**HIGH RESISTANCE**  
suitable for a traffic and ground load  
untill 60 SLW (heavy trucks of 60 tons)

**SLW 60**  
Truck 60t

At the strength testing, made by the MFPA, our Rigoletto inspection block showed ist high vertical and horizontal loading capacity.

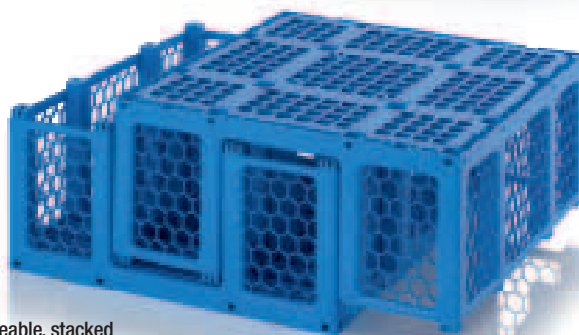

Replaceable, stacked  
for the transport

## RAINWATER SOAKAWAY RIGOLETTO

Article No.	Article description	Dimensions L x W x H (cm)	Gross volume	Storage volume	Weight	Units per pallet	Price/Unit on pallet
RG88-G	Rigoletto inspection canal closed	80 x 80 x 35	244l	211l	9,57kg	8	35,05 €
RG88-O	Rigoletto inspection canal open	80 x 80 x 35	244l	211l	9,35kg	10	32,04 €
RG88-GP	Rigoletto base plate	80 x 80 x 5	-	-	5kg	52	14,99 €



To complete the inspection tunnel there are suitable front wall grids available. Front wall adapters are provided for the direct pipe connection, which just have to be clicked onto the front of the Rigoletto.

Block connectors are used to secure the position of the Inspection Block Rigoletto during the installation. The block connectors are in the middle of the wall for mounting.

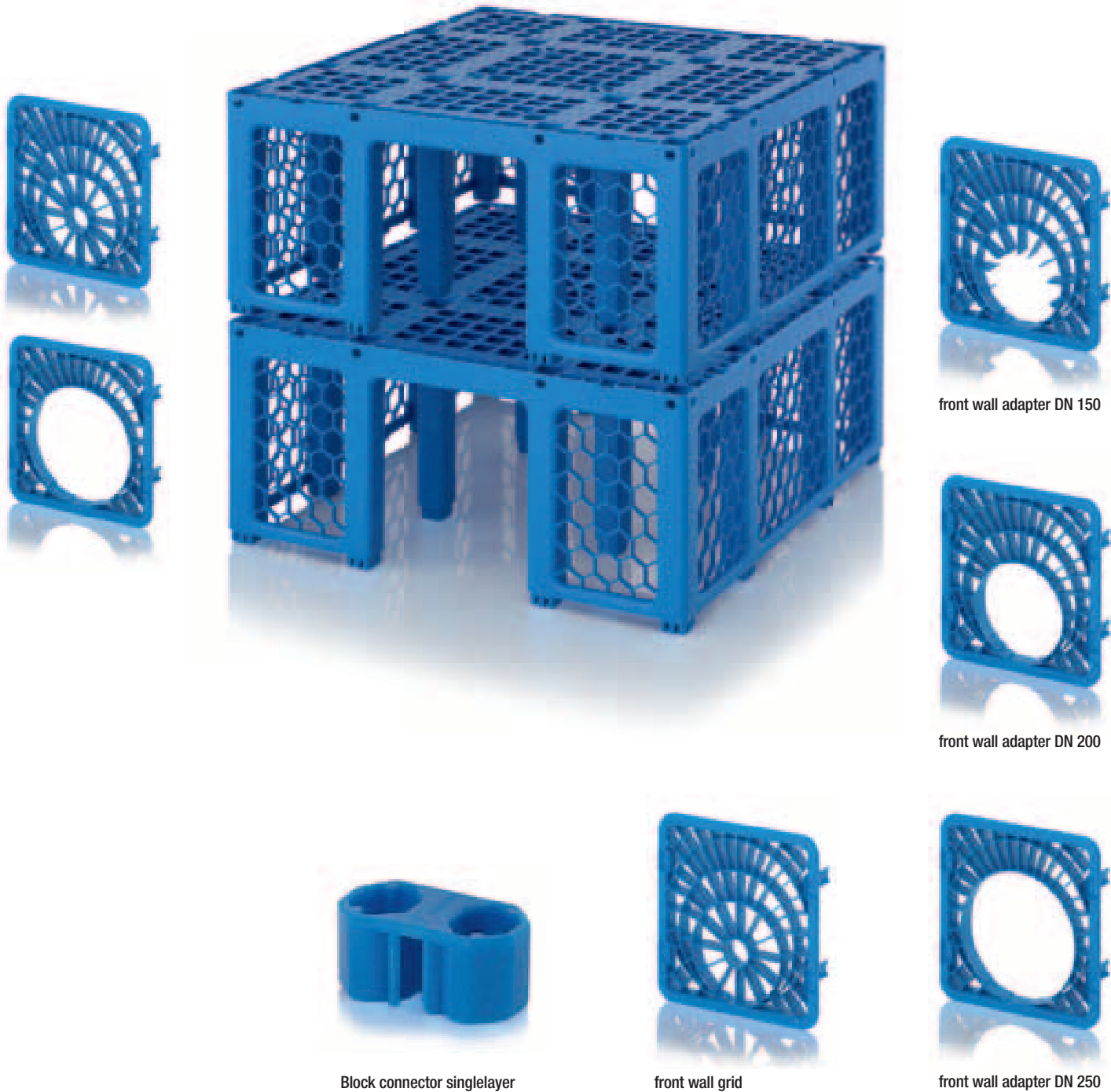

front wall adapter DN 150

front wall adapter DN 200

Block connector singlelayer

front wall grid

front wall adapter DN 250

Rainwater  
Soakaway  
Rigoletto

## BLOCK CONNECTOR

Article No.	Article description	Laying	Requirements	Price/Unit
RG88-BV1	Block connector singlelayer	single row	1 piece per block	0,32 €
		multiple row	2 pieces per block	

## FRONT WALL GRID AND FRONT WALL APAPTER

Article No.	Article description	Dimensions L x W (cm)	Price/Unit
RG88-SG	front wall grid	28 x 32 cm	3,38 €
RG88-SA150	front wall adapter DN 150	28 x 32 cm	3,20 €
RG88-SA200	front wall adapter DN 200	28 x 32 cm	3,04 €
RG88-SA250	front wall adapter DN 250	28 x 32 cm	2,74 €

# BOTTLE CRATE

## FLAGSHIP FOR YOUR BRAND



**F1 OPEN FOR  
NEW VIEWS**  
20 X 0,5L



**F2 COMPLETE SIDES  
FOR YOUR BRAND**  
20 X 0,5L



**F3 EXCITEMENT DUE TO  
SHAPES AND OPPOSITES**  
20 X 0,5L



**F4 FOR PILS AND  
OTHER 0,33L BOTTLES**  
24 X 0,33L



**F5 GRAND ENTRANCE  
FOR SMALL BOTTLES**  
24 X 0,33L



**F6 PERFECT SIGHT TO  
SIX 1,5L BOTTLES**  
6 X 1,5L



**F7 IDEAL FOR  
SNAP-TOP BOTTLES**  
20 X 0,5L



**F8 UNIQUE IN  
ANY WAY**  
20 X 0,5L



**F9 IMPRESSIONS  
FROM ALL SIDES**  
12 X 0,5L



**F10 ACTIVE FOR  
POWERFUL BRANDS**  
8 X 0,75L



**F11 SIMPLE AND  
TIMELESS ELEGANCE**  
11 X 0,5L



**F12 YOUR DESIGN  
ON THE SIDE WALLS**  
20 X 0,5L



**F13 PERFECT STAGING  
OF YOUR LABEL DESIGN**  
20 X 0,5L

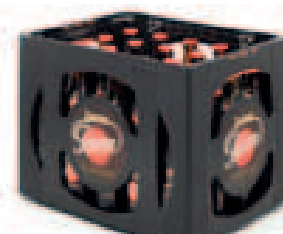

**F14 FOCUS  
ON THE BRAND**  
20 X 0,5L



**F15 SEPARABLE  
FOR TWICE THE SUCCESS**  
20 X 0,5L

That will perfectly stage your bottle design: The big side opening shows one bottle in its full height, the two bottles next to are half-visible.

On every corner an oval sight opening will make your main and bottle neck labels an attractive eye-catcher.

- Inmould-Labeling
- Soft-touch handle
- 20 x 0,5l



## BOTTLE CRATE MODEL F13

Article No.	Colour	Model	Units per carton	Price/Unit in carton	Units per pallet	Price/Unit on pallet
F13	blue	20 x 0,5l	6	7,13 €	70	5,94 €

Delivery free of charge from one pallet

# SPECIAL COLOURS

## WE ARE MULTI-COLOURED!

Your company colour is RAL 5005 signal blue? What would you say, if your AUER-Boxes are delivered in that colour? On request and for a small extra charge, we can produce the desired articles in one of the shown standart colours, or every other RAL-colour.

Just ask us and we will be glad to submit you an individual offer!



RAL 1003

signal yellow



RAL 1028

melon yellow



RAL 3020

traffic red



RAL 4006

traffic purple



RAL 5003

sapphire-blue



RAL 5005

signal blue



RAL 5015

sky blue



RAL 6005

moss green



RAL 6018

yellow green



RAL 6029

mint green



RAL 7001

silver grey

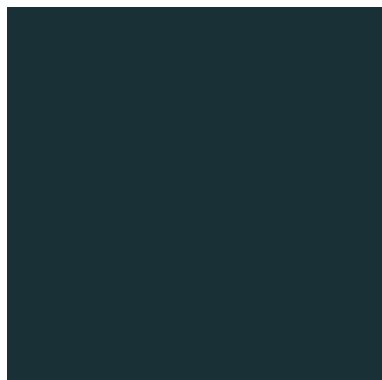

RAL 7016

anthracite grey



RAL 8017

chocolate brown

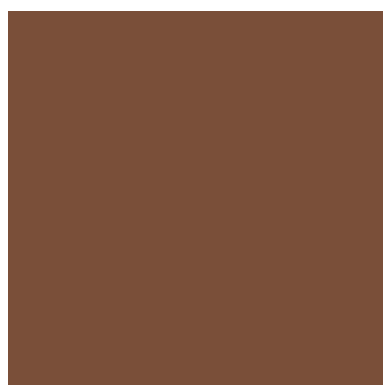

RAL 8024

light brown

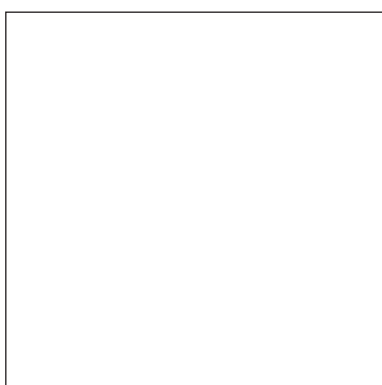

RAL 9016

traffic white

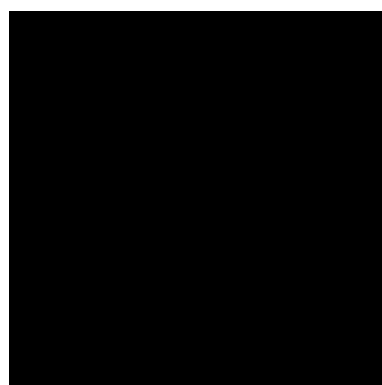

RAL 9017

traffic black

Please notice that the colours used here look different on your monitor and are therefore not binding.

# LABEL HOLDER

THERE IS NO EASIER WAY!



You have never been able to establish order in your warehouse this fast. Just take one sheet of paper or a small card and clip it under the label holder - and ready!

## LABEL HOLDER

Article No.	Colour	Units per carton	Price/Unit in carton
ET	silver grey	100	0,90 €

# SELF-ADHESIVE BAGS

MAXIMUM OVERVIEW



Back foil: 100 µ SK-foil,  
Front foil: 140 µ transparent soft foil,  
Open on the wide side,  
the backside is bigger than the front side.  
The back side is completely self-adhesive.

Order now & save money!  
e.g.  
Self-adhesive pocket  
A6 crosswise  
7034  
Price/Unit in carton

Our best price  
from €

**0,27**

## SELF-ADHESIVE BAGS

Article No.	Model	Units per carton	Price/Unit in carton
7034	self-adhesive pocket A6 crosswise	300	0,27 €
7035	self-adhesive pocket A5 crosswise	300	0,36 €
7036	self-adhesive pocket A4 crosswise	300	0,55 €

# IMPRINTINGS

NO PROBLEM FOR US!



You want to design AUER containers according to your company profile? No problem! We can imprint our containers with your logo or your advertising prints.

Please do not hesitate to contact us about this possibility. We will make an individual offer according to your requirements!

Order now & save money!  
e.g.  
Printing Euro containers  
40 x 30 cm – 80 x 60 cm  
Price/Unit 1-sided













Our best price  
from €

**1,20**

## IMPRINTINGS

Article	Base (cm)	1 – 50 per pcs.		51 – 100 per pcs.		101 – 200 per pcs.	
		1-sided	2-sided	1-sided	2-sided	1-sided	2-sided
Euro containers	40 x 30 – 80 x 60	3,00 €	4,50 €	1,50 €	2,25 €	1,20 €	1,80 €
Big Boxes	120 x 80 x 79 – 120 x 100 x 100	10,00 €	15,00 €	5,00 €	7,50 €	3,00 €	4,50 €
Lids	40 x 30 – 80 x 60	3,00 €	4,50 €	1,50 €	2,25 €	1,20 €	1,80 €
Lids	120 x 80 – 120 x 100	10,00 €	15,00 €	5,00 €	7,50 €	3,00 €	4,50 €
Pallets	80 x 60 – 120 x 100	10,00 €	15,00 €	5,00 €	7,50 €	3,00 €	4,50 €
Transport Trolley		3,00 €	not possible	1,50 €	not possible	1,20 €	not possible
Pails	Labeling	5,00 €	7,50 €	4,00 €	6,00 €	3,00 €	4,50 €
Printing plate	205,00 €						

## EXPERIENCE AUER PACKAGING LIVE!

	EVENT / DATE	YOU FIND US IN	LINK TO FAIR WEBSITE
	HISPACK 2012 Barcelona, Spain 15. - 18.05.2012	Hall 101 Booth 101	<a href="http://www.hispack.com">www.hispack.com</a>
	FACHPACK 2012 Nuremberg, Germany 25. - 27.09.2012	Hall 6 Booth 6-441	<a href="http://www.fachpack.de">www.fachpack.de</a>
	MACROPAK Utrecht, Netherlands 02. - 05.10.2012	Hall 8 Booth B071	<a href="http://www.macropak.nl">www.macropak.nl</a>
	MOTEK Stuttgart, Germany 08. - 11.10.2012	Hall 7 Booth 7131	<a href="http://www.motek-messe.de">www.motek-messe.de</a>
	FAKUMA Friedrichshafen, Germany 16. - 20.10.2012	Hall B5 Booth 5225	<a href="http://www.fakuma-messe.de">www.fakuma-messe.de</a>
	PACK EXPO 2012 Chicago, USA 28. - 31.10.2012	Hall Lakeside Upper Booth 6615	<a href="http://www.packexpo.com/pei2012/">www.packexpo.com/pei2012/</a>
	HEALTH INGREDIENTS Frankfurt, Germany 13. - 15.11.2012	Hall 3 Booth H44	<a href="http://hieurope.ingredientsnetwork.com">hieurope.ingredientsnetwork.com</a>
	BRAU BEVIALE Nuremberg, Germany 13. - 15.11.2012	Hall 4 Booth 337 + 432	<a href="http://www.brau-beviale.de">www.brau-beviale.de</a>
	EMBALLAGE Paris, France 19. - 22.11.2012	Hall 5a	<a href="http://en.emballageweb.com">en.emballageweb.com</a>
	PACK & MOVE 2012 Basel, Switzerland 20. - 23.11.2012	Hall 2 Booth H22	<a href="http://www.packmove.ch">www.packmove.ch</a>
	LOGIMAT Stuttgart, Germany 19. - 21.02.2013	Hall 5 Booth 231	<a href="http://www.logimat-messe.de">www.logimat-messe.de</a>
	DRINKTEC Munich, Germany 16. - 20.09.2013	Hall A2 Booth 500	<a href="http://www.drinktec.com">www.drinktec.com</a>

The logo for Continental, featuring the word "Continental" in a gold, serif font on a black rectangular background, with a small gold circle containing a cross to the right.The classic Coca-Cola logo in its signature red script font with a white outline.The OMV logo, consisting of the letters "OMV" in a bold, blue, sans-serif font, with a horizontal line through the middle of the letters, and the word "OMV" repeated below it.The Samsung logo, featuring the word "SAMSUNG" in a white, sans-serif font inside a blue, horizontally-oriented oval.The Konica Minolta logo, featuring a blue sphere with horizontal white lines, and the words "KONICA MINOLTA" in a black, sans-serif font below it.The Melitta logo, featuring the word "Melitta" in a red, cursive script font, with a small blue wave-like shape below it.The Bosch logo, featuring a black circle with a white 'H' inside, followed by the word "BOSCH" in a bold, red, sans-serif font.The Siemens logo, featuring the word "SIEMENS" in a bold, teal, sans-serif font.The Osram logo, featuring the word "OSRAM" in a bold, orange, sans-serif font, followed by a circular icon containing a white lightbulb.The Dr. Oetker logo, featuring the words "Dr. Oetker" in a white, sans-serif font inside a red, rounded rectangular shape, with a small white silhouette of a person's head below the text.The BASF logo, featuring a blue square with a white square inside, followed by the word "BASF" in a white, sans-serif font, and the tagline "The Chemical Company" in a smaller white font below it.The Danone logo, featuring the word "DANONE" in a white, sans-serif font inside a blue, rounded rectangular shape, with a red and blue wave-like shape below it.The Obi logo, featuring the word "OBI" in a bold, orange, sans-serif font.The tesa logo, featuring the word "tesa" in a white, sans-serif font on a red background, with a blue triangle pointing to the right.The Panasonic logo, featuring the word "Panasonic" in a bold, blue, sans-serif font.





Dior



**HARIBO**

**FERRERO**

**BRIDGESTONE**

**NOKIA**  
Connecting People





AUER PACKAGING INTERNATIONAL  
Technologiepark  
Am Kroit 25/27  
D-83123 Amerang  
Tel. +49 (0)8075/91333-20  
Fax +49 (0)8075/91333-29  
info@auer-packaging.com  
www.auer-packaging.com



AUER PACKAGING ÖSTERREICH  
[www.auer-packaging.at](http://www.auer-packaging.at)



AUER PACKAGING FINNLAND  
[www.auer-packaging.fi](http://www.auer-packaging.fi)



AUER PACKAGING POLSKA  
[www.auer-packaging.pl](http://www.auer-packaging.pl)



AUER PACKAGING BELGIË  
[www.auer-packaging.be](http://www.auer-packaging.be)



AUER PACKAGING FRANCE  
[www.auer-packaging.fr](http://www.auer-packaging.fr)



AUER PACKAGING SRL  
[www.auer-packaging.ro](http://www.auer-packaging.ro)



AUER PACKAGING SWISS GMBH  
[www.auer-packaging.ch](http://www.auer-packaging.ch)



AUER PACKAGING MAGYARORSZÁG  
[www.auer-packaging.hu](http://www.auer-packaging.hu)



AUER PACKAGING RUSSIA  
[www.auer-packaging.ru](http://www.auer-packaging.ru)



AUER PACKAGING  
ČESKÁ REPUBLIKA  
[www.auer-packaging.cz](http://www.auer-packaging.cz)



AUER PACKAGING ITALIA  
[www.auer-packaging.it](http://www.auer-packaging.it)



AUER PACKAGING SWEDEN  
[www.auer-packaging.se](http://www.auer-packaging.se)



**HEADQUARTER**  
AUER PACKAGING GMBH  
[www.auer-packaging.de](http://www.auer-packaging.de)



AUER PACKAGING MEXIKO  
[www.auer-packaging.mx](http://www.auer-packaging.mx)



AUER PACKAGING SLOVAKIA  
[www.auer-packaging.sk](http://www.auer-packaging.sk)



AUER PACKAGING DANSK  
[www.auer-packaging.dk](http://www.auer-packaging.dk)



AUER PACKAGING NEDERLAND  
[www.auer-packaging.nl](http://www.auer-packaging.nl)



AUER PACKAGING U.K.  
[www.auer-shop.co.uk](http://www.auer-shop.co.uk)



AUER PACKAGING ESPAÑA  
[www.auer-packaging.es](http://www.auer-packaging.es)



AUER PACKAGING NORWAY  
[www.auer-packaging.no](http://www.auer-packaging.no)



AUER PACKAGING USA  
[www.auer-packaging.us](http://www.auer-packaging.us)

